



APEX Tool Group(ATG)is one of the professional manufacturer of hand tools and power tools. We provide professional products and first-class service for aerospace manufacturing, automotive assembly lines, electronic production lines and other industrial production, automotive maintenance, construction and other industries.

We have more than 30 well-known brands, most of which are industry or category leaders, such as SATA®, GEARWRENCH®, Cleco®, Weller®, Crescent®, Wiss®, Lufkin®, APEX®. Globally, our tools represent quality, innovation and value, and are committed to solving difficulties for our customers, with a long time of the Group's brands renowned for their efficiency and innovation.



ATG operates in more than 30 countries and regions around the world, has more than 20 factories in North America, South America, Europe, Australia, Asia and other regions, more than 8,000 employees, in the United States, Germany, France and China has four research and development centers, operating in 120 countries around the world. ATG works closely with distributors, retailers and KA customers around the world to ensure that our end customers have the tools to solve actual problems. Our unique category management provides our customers with end-of-point data, consumer research, and market feedback that helps with inventory flow, product presence and promotion decisions. At the same time, ATG's truly global footprint offers a more service advantage than any regional enterprise to meet the needs of its customers.

# APEX Memorabilia

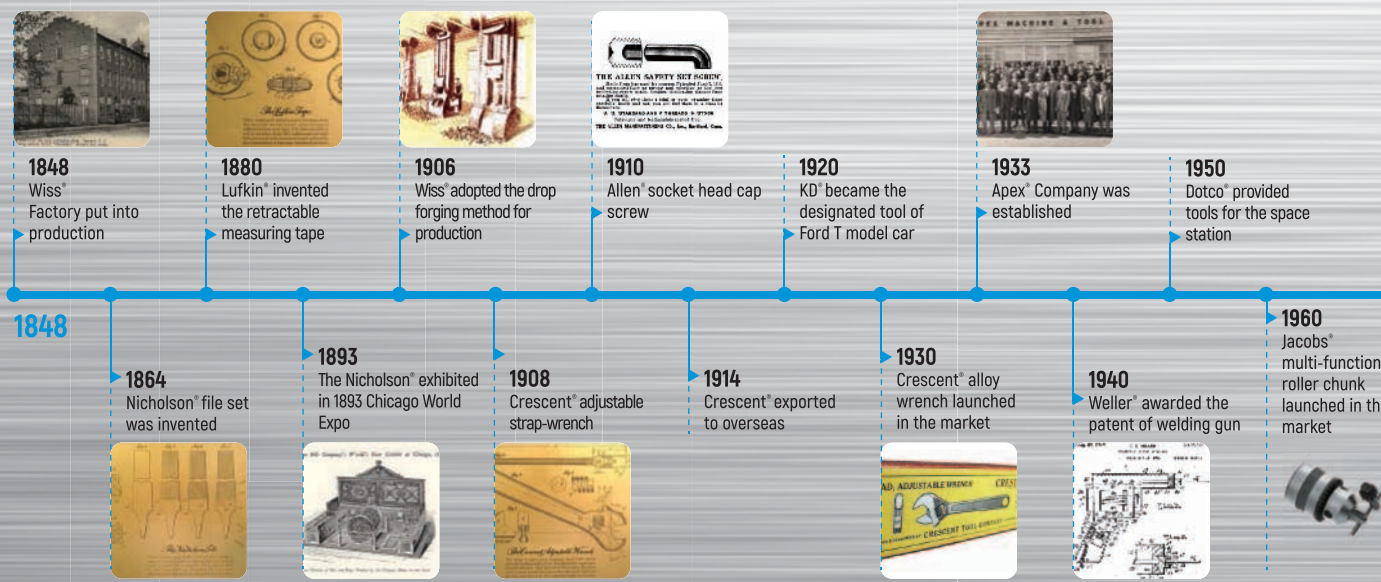

- 1848** Wiss' Factory put into production
- 1864** Nicholson' file set was invented
- 1880** Lufkin' invented the retractable measuring tape
- 1893** The Nicholson' exhibited in 1893 Chicago World Expo
- 1906** Wiss' adopted the drop forging method for production
- 1908** Crescent' adjustable strap-wrench
- 1910** Allen' socket head cap screw
- 1914** Crescent' exported to overseas
- 1920** KD' became the designated tool of Ford T model car
- 1930** Crescent' alloy wrench launched in the market
- 1933** Apex' Company was established
- 1940** Weller' awarded the patent of welding gun
- 1950** Dotco' provided tools for the space station
- 1960** Jacobs' multi-functional roller chunk launched in the market

# APEX Tool Group



Hand Tools



Power Tools



Auto Equipment



**1965**  
GearWrench® Taiwan Factory put into production

**1987**  
Armstrong® wrench won the status of World First Wrench Brand



**1995**  
Ratchet wrench brand GearWrench® was established

**2002**  
SATA® became the tool brand with large market share in China



**2005**  
SATA ShangDong Factory put into production

**2014**

- Nicholson's 150th anniversary
- Designed a drive tool for Mortorg Super Helix Drive
- Crescent establishes Pivot Pro pliers brand
- KD Tools join GearWrench family



**2017**  
Cleco introduces NeoTek tool

**2020**

**1983**  
Armstrong® sleeve won the status of World First Sleeve Brand

**1992**  
SATA® Shanghai Factory put into production



**1997**  
The Chinese market brand SATA® was established



**2002**  
The sales volume of GearWrench® wrench exceeded 100,000,000 pcs



**2013**  
Bain Capital acquired APEX Group



**2015**  
SATA successfully merged Shanghai Yicheng Auto-inspection Device Science & Technology Co., LTD



**2019**  
SATA Automotive Technology(Shanghai)Co.,Ltd was established



- Crescent Apex Dual-brand sleeve head launched



# About Us

**SATA, as the leading brand in China, has been making important contributions to Chinese economic growth and the development of the Industrial and Automotive aftermarket.**

SATA is a subsidiary of U.S.-based Apex Tool Group. We have launched a full line of tools and auto equipment to support skilled technicians and their need for the most advanced equipment to serve the rapidly-growing Chinese market. With our strong international background and decades of experience in engineering, R&D, manufacturing and marketing, SATA looks forward to becoming the best product solutions provider in the industry. SATA will continuously serve our customers depend on our innovation, superior products, application knowledge and responsive service, as well as our convenient service network throughout China.



# SATA History



# SATA Champion Store

SATA Champion Store is a project launched by SATA AE for providing one-stop solution for auto repair shop. Compared with the traditional workshop mode, SATA Champion Store will provide the comprehensive auto equipments products and MRO tools, professional new shop consulting, workshop operation & management software and after-sales services to completely meet the demands of customers through one-stop service.

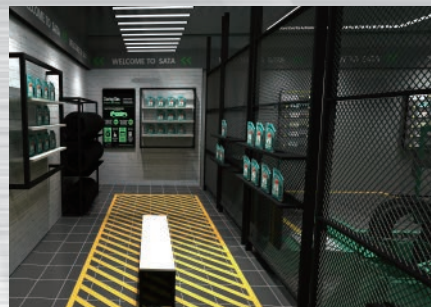
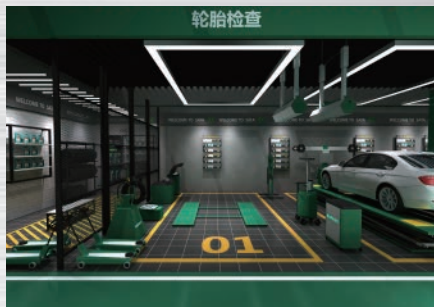

SATA Personal Protective Equipment (PPE) launched in the market

2011



Bain Capital acquired Apex Tool Group

2013



SATA successfully merged Shanghai Yicheng Auto-inspection Device Science & Technology Co., LTD

2015



SATA brought Apex fastener Drive Tools into Chinese Market

2017



SATA Technology Innovation Center Overseas business integration

2019

2010

APEX Tool Group was established, SATA is the wholly owned subsidiary



2012

SATA Auto Maintenance Equipment Series Products launched in the market



2014

SATA China First Autoaintenance Experience Center opened in Shanghai



2016

SATA brought Apex fastener Drive Tools into Chinese Market



2018

SATA New Logo & VI System Launched on the occasion of the SATA 20th Anniversary.

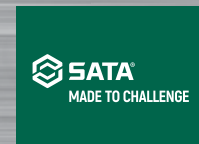

2020

Senior partner of The first Vocational Skills Competition of the People's Republic of China





**Support Education SATA Pioneer** | SATA since the launch of the support for high erial professional personnel training program in 2007, for many years has been committed to school-enterprise cooperation, has become one of the earliest financial professional education enterprises in the country. From 2007 signed the "school-enterprise cooperation" agreement with the Ministry of Education for the first time, has been more than ten years, a total of more than 11 million RMB worth of donated products, sponsorship of secondary vocational and technical schools 490, higher vocational and technical schools 149, design auto engineering students 280,000 people, for China's automotive industry and auto maintenance&repair industry has made a positive contribution to the training of talent.

### 2007-2019 SATA Vocational Education Sponsorship

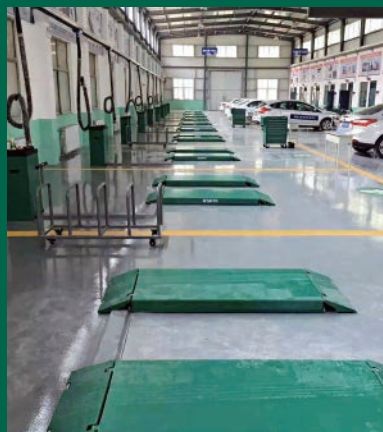



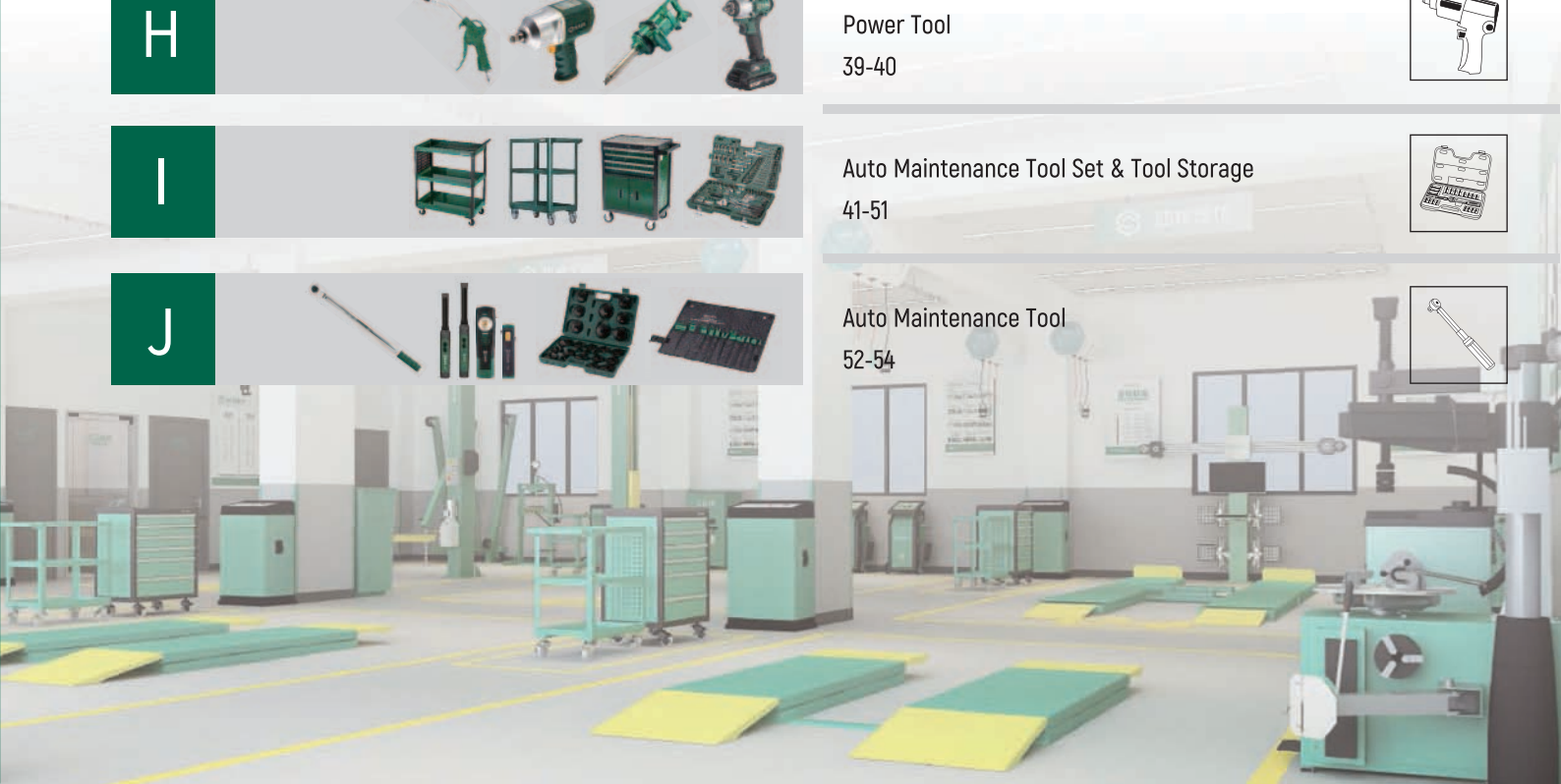

# Contents | Product Catalog

A		<p>Car Lift 1-10</p>	
B		<p>Four Wheel Aligner 11-12</p>	
C		<p>Tire Equipment &amp; Tool 13-22</p>	
D		<p>Air Compressor 23-25</p>	
E		<p>Oil and Liquid Equipment 26-29</p>	
F		<p>Other Auto Maintenance Equipment 30-35</p>	
G		<p>Lifting &amp; Jack Tools 36-38</p>	
H		<p>Power Tool 39-40</p>	
I		<p>Auto Maintenance Tool Set &amp; Tool Storage 41-51</p>	
J		<p>Auto Maintenance Tool 52-54</p>	



# A

## Car Lift

Scissor Alignment Lift		1-3
Four Post Alignment Lift		4
Scissor Lift		5-6
Two Post Lift		7-10



### AE5302 / AE5302-3 4T Scissor Lift For Aligner



#### Technical parameter:

Model	AE5302	AE5302-3
Voltage	220V	380V
Capacity	4T	4T
Min. Height	330mm	330mm
Host lift Height	1850mm	1850mm
Secondary Jack Lift Height	435mm	435mm
Rise Time	60S	60S
Drop Time	50S	50S
Motor Power	3KW	3KW
Platform Length of Secondary jack	1400mm	1400mm
Platform Length of Host Machine	4500mm	4500mm
Motor Shell	Aluminum alloy	Aluminum alloy
Mechanical Insurance Tooth	3 teeth	3 teeth
Unlock Detection	Yes	Yes
Electric Control	24V Control box	24V Control box

#### Features:

- Machine weight is 2100KG
- The whole machine passed 1.5 times load test
- Arm design optimization to ensure full load down to the lowest position with stable status
- Italian imported filling valve, with good seal
- The rectangular tube of the platform adopts 150x50 specification to increase its strength
- Three teeth protection, improve the strength of the insurance block
- Aluminum alloy motor, fast heat dissipation
- The platform adopts steel plate bending technology, increase the strength
- 3KW motor, reduce the motor load rate.
- 4500mm extended platform, suitable for more vehicle model
- The reinforcing bar at the bottom of the platform is designed with U-shaped steel to increase the strength
- Electronic detection of the state of insurance, to avoid falling in the process of insurance not fully open caused by potential safety hazards
- 24V safety voltage control, more safe operation
- SATA PCB control, high efficiency and stability

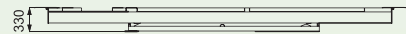
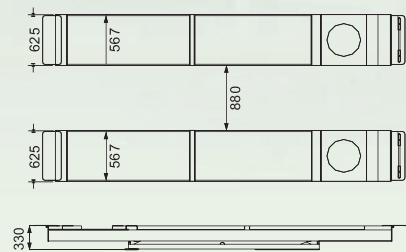
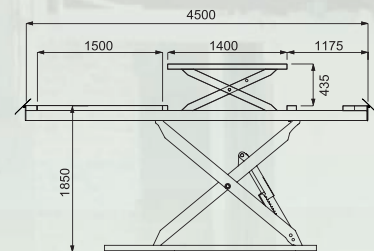



# AE5402 /AE5402-3 4T Ultrathin Scissor Lift For Aligner

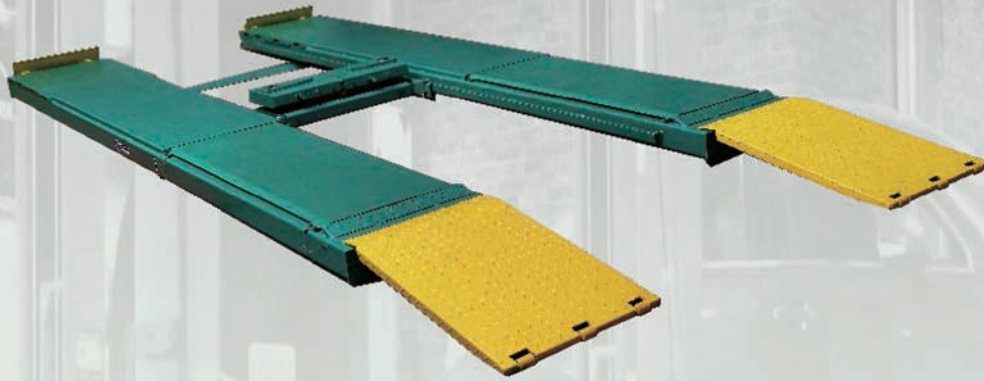

## Technical parameter:

Model	AE5402	AE5402-3
Voltage	220V	380V
Host Machine Capacity	4T	4T
Secondary Jack Capacity	2T	2T
Rise Time	60S	60S
Drop Time	50S	50S
Min. Height	130mm	130mm
Host lift Height	1600mm	1600mm
Secondary Jack Lift Height	405mm	405mm
Platform Length	4520mm	4520mm
Platform Width	690mm	690mm
Motor Power	3.0KW	3.0KW
Electric Control	24V Control box	24V Control box
Motor Shell	Aluminum alloy	Aluminum alloy
Unlock Detection	Yes	Yes

## Features:

- Machine weight is 2100KG
- The whole machine passed 1.5 times load test
- The platform adopts the whole plate bending technology, increase the strength
- Arm design optimization to ensure full load down to the lowest position with stable status
- Arm design optimization to ensure full load down to the 200mm height with stable status
- Italian imported filling valve, with good seal
- The minimum height is 130mm, convenient for boarding
- Electronic detection of the state of insurance, to avoid falling in the process of insurance not fully open caused by potential safety hazards
- Double protection of mechanical and hydraulic to improve safety and reliability
- Aluminum alloy motor, fast heat dissipation
- 3KW motor, reduce the motor load rate.
- 24V safety voltage control, more safe operation
- 4500mm extended platform, suitable for more vehicle model
- SATA PCB control, high efficiency and stability

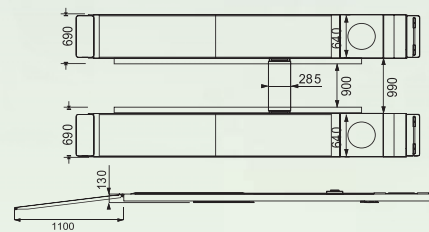
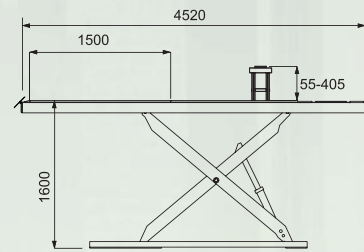

# AE5402A / AE5402A-3 4T Ultrathin Scissor Lift For Aligner



## Technical parameter:

Model	AE5402A	AE5402A-3
Voltage	220V	380V
Capacity	4T	4T
Min. Height	180mm	180mm
Host lift Height	1630mm	1630mm
Secondary Jack Lift Height	430mm	430mm
Rise Time	60s	60s
Drop Time	50s	50s
Platform Length of Secondary jack	1540mm-1750mm	1540mm-1750mm
Platform Length	4520mm	4520mm
Platform Width of Secondary Jack	600mm	600mm
Platform Width	655mm	655mm
Air Pressure	6-8bar	6-8bar
Motor Power	3KW	3KW
Motor Shell	Aluminum alloy	Aluminum alloy
Unlock Detection	Yes	Yes
Electric Control Method	SATA PCB Patent control	SATA PCB Patent control

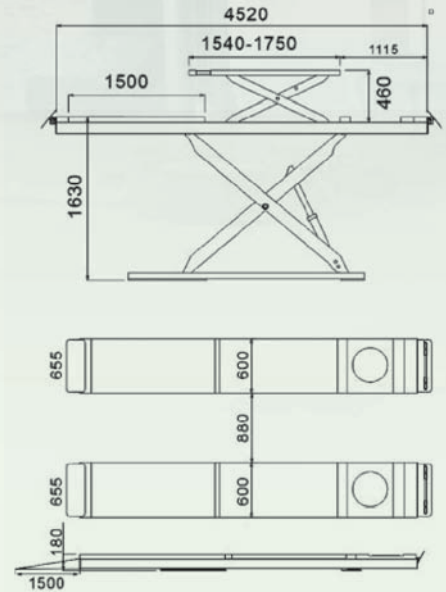

## Features:

- Electronic detection of the open state of the insurance to avoid safety hazards caused by the failure of the insurance
- Mechanical and hydraulic double protection, safe and reliable
- Aluminum alloy motor, fast heat dissipation
- 3KW motor, reduce the motor load rate
- The minimum height is 180mm, convenient for boarding
- SATA PCB control, high efficiency and stability
- Italian imported filling valve, with good seal
- The platform adopts the whole plate bending technology, increase the strength
- Arm design optimization, the lowest position is fully loaded and lifted smoothly
- Arm design optimization, when it drops to the lowest position with full load, it descends smoothly
- 4520mm extended platform, suitable for more vehicle model

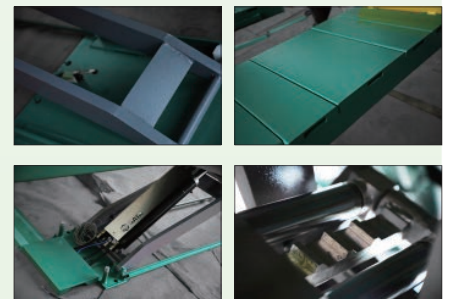

## AE5202 /AE5202-3 4.5T 4 Post Lift For Aligner



### Technical parameter:

Model	AE5202	AE5202-3
Voltage	220V	380V
Capacity	4.5T	4.5T
Min. Lift Height	210mm	210mm
Max.Lift Height	1700mm	1700mm
Rise Time	60S	60S
Drop Time	50S	50S
Motor Power	2.2KW	2.2KW
Motor Shell	Aluminum alloy	Aluminum alloy
Machine Height	2018mm	2018mm
Width between column	2830mm	2830mm
Track Width	3185mm	3185mm
Platform Length	4510mm	4510mm
Electric Control	24V Control box	24V Control box
Unlock Detection	Yes	Yes
Lock Release	Penumatic	Penumatic

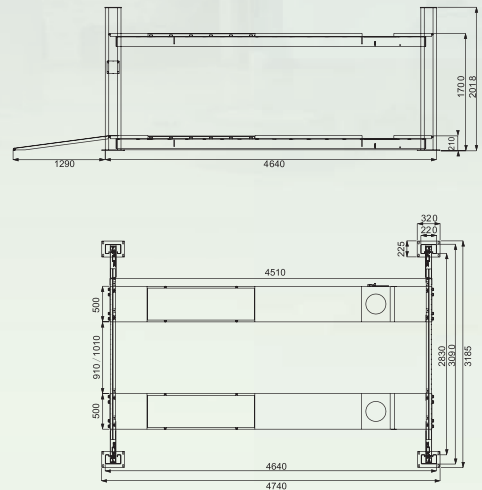

### Features:

- Machine weight is 1300KG
- The whole machine passed 1.5 times load test
- The platform adopts steel plate bending technology,increase the strength
- The reinforcing bar at the bottom of the platform is designed with U-shaped steel to increase the strength
- Electronic detection of the state of insurance, to avoid falling in the process of insurance not fully open caused by potential safety hazards
- Wire rope fracture protection, avoid wire rope fracture caused safety hazard
- Aluminum alloy motor, fast heat dissipation
- Penumatic lock release with single side, more safe operation
- 24V safety voltage control, more safe operation
- 4510mm extended platform, suitable for more vehicle model



## AE5502/AE5502-3 3.5T Scissor Lift

### Technical parameter:

Model	AE5502	AE5502-3
Voltage	220V	380V
Capacity	3.5T	3.5T
Min. Height	330mm	330mm
Lift Height	1999mm	1999mm
Motor Power	3KW	3KW
Platform Length	1660-2080mm	1660-2080mm
Rise Time	60S	60S
Drop Time	50S	50S
Motor Shell	Aluminum alloy	Aluminum alloy
Mechanical Insurance Tooth	3 teeth	3 teeth
Unlock Detection	Yes	Yes
Electric Control	24V Control box	24V Control box

### Features:

- Machine weight is 750KG
- The whole machine passed 1.5 times load test
- Italian imported filling valve, with good seal
- Electronic detection of the state of insurance, to avoid falling in the process of insurance not fully open caused by potential safety hazards
- Three teeth protection, improve the strength of the insurance block
- Aluminum alloy motor, fast heat dissipation
- 3KW motor, reduce the motor load rate.
- Double pull platform, suitable for more vehicle model
- 24V safety voltage control, more safe operation
- SATA PCB control, high efficiency and stability

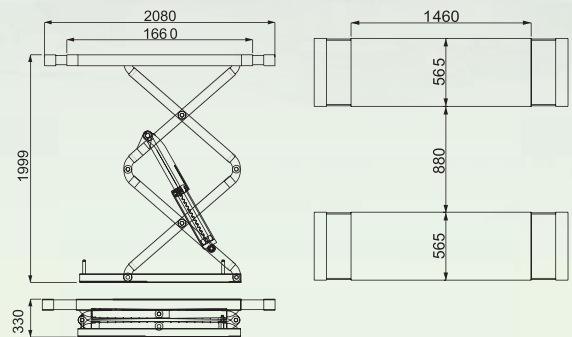

## AE5505/AE5505-3 3.6T Ultrathin Scissor Lift

### Technical parameter:

Model	AE5505	AE5505-3
Voltage	220V	380V
Capacity	3.6T	3.6T
Min. Height	120mm	120mm
Lift Height	1880mm	1880mm
Platform Length	1480-2090mm	1480-2090mm
Rise Time	60S	60S
Drop Time	50S	50S
Motor Power	3KW	3KW
Motor Shell	Aluminum alloy	Aluminum alloy
Unlock Detection	Yes	Yes
Electric Control	24V Control box	24V Control box

### Features:

- Machine weight is 950KG
- The whole machine passed 1.5 times load test
- The platform adopts the whole plate bending technology, increase the strength
- Arm design optimization to ensure full load down to the lowest position with stable status
- Arm design optimization to ensure full load down to the 200mm height with stable status
- Italian imported filling valve, with good seal
- The minimum height is 110mm, convenient for boarding
- Electronic detection of the state of insurance, to avoid falling in the process of insurance not fully open caused by potential safety hazards
- Double protection of mechanical and hydraulic to improve safety and reliability
- Aluminum alloy motor, fast heat dissipation
- 3KW motor, reduce the motor load rate.
- The support plate adopts tilt up design, ensure the support plate level after load
- 24V safety voltage control, more safe operation
- SATA PCB control, high efficiency and stability

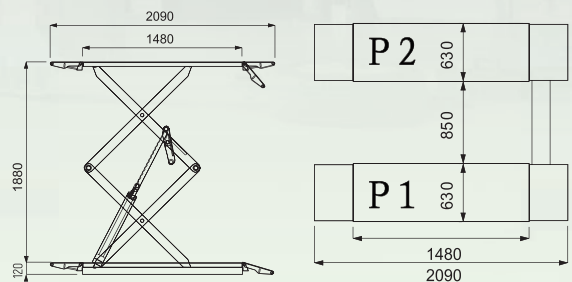
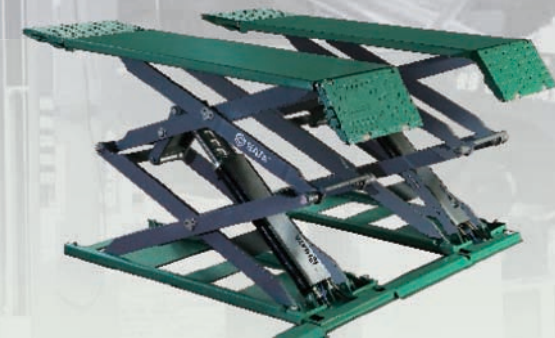

## AE5510 /AE5510-3 3.5T Scissor Lift (single-Pull)

### Technical parameter:

Model	AE5510	AE5510-3
Voltage	220V	380V
Capacity	3.5T	3.5T
Min. Height	330mm	330mm
Lift Height	2140mm	2140mm
Platform Length	1660-2000mm	1660-2000mm
Platform Width	565mm	565mm
Total Width	2010mm	2010mm
Rise Time	60s	60s
Drop Time	50s	50s
Air Pressure	6-8bar	6-8bar
Motor Power	2.2KW	2.2KW
Motor Shell	Aluminum alloy	Aluminum alloy
Mechanical Insurance Tooth	3 teeth	3 teeth

### Features:

- Mechanical and hydraulic double protection, safe and reliable
- Aluminum alloy motor, fast heat dissipation
- Three teeth protection, improve the strength of the insurance block
- 1660mm extended platform with single-pull, suitable for more vehicle model
- Italian imported filling valve, with good seal

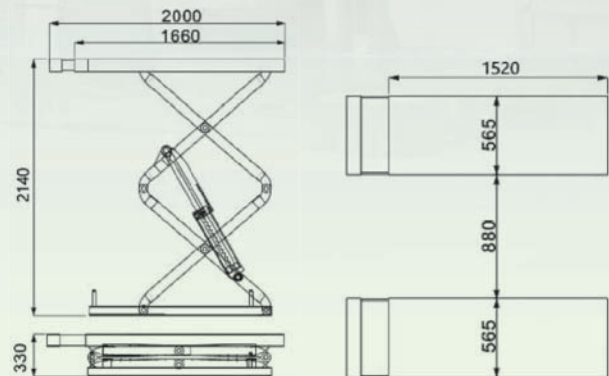

## AE5828 New energy vehicles battery Lift

### Technical parameter:

Model	AE5828
Voltage	220V
Capacity	1T
Min. Height	570mm
Lift Height	1930mm
Platform Length	1500mm
Platform Width	800mm
Height from the ground	250mm
Total Width	945mm
Total Length	2250mm
Rise Time	55s
Drop Time	40s
Motor Power	1.6KW
Mechanical Insurance	High-strength insurance block
Weight	548kg

### Features:

- Mechanical and hydraulic double protection, safe and reliable
- Dual-cylinder design, stable operation
- Floating working platform, which can move freely within 35mm
- Charging port, charging operation is simple, fast and safe
- Adsorption type handheld wired controller, humanized design, easy to operate
- High-load movable casters, wear-resistant, flexible steering
- Hydraulic lifting trailer, fast and safe to move
- Standard fixture support frame for easy disassembly and assembly of different car components

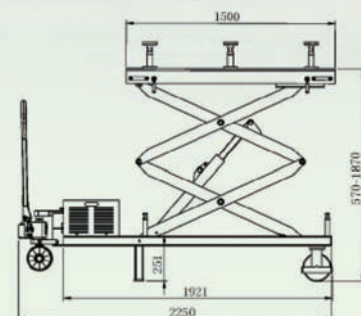

## AE5102/AE5102-3 4T 2 Post Lift Clear Floor



### Technical parameter:

Model	AE5102	AE5102-3
Voltage	220V	380V
Capacity	4T	4T
Min. Lift Height	95mm	95mm
Max.Lift Height	1990mm	1990mm
Rise Time	60S	60S
Drop Time	50S	50S
Motor Power	2.2KW	2.2KW
Motor Shell	Aluminum alloy	Aluminum alloy
Machine Height	3900mm	3900mm
Width between column	3000mm	3000mm
Track Width	3580mm	3580mm
Tray Thread	3-step 70mm Adjustable	3-step 70mm Adjustable
Raised Adaptor height	70mm	70mm
Type of Arm	2-step straight arm+3-step straight arm	2-step straight arm+3-step straight arm
Electric Control	24V Control box	24V Control box
Lock Release	Manual unlock with single side	Manual unlock with single side

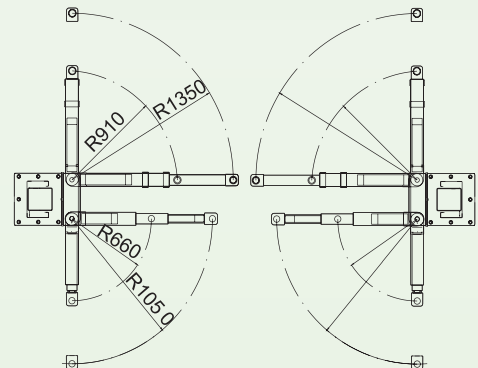
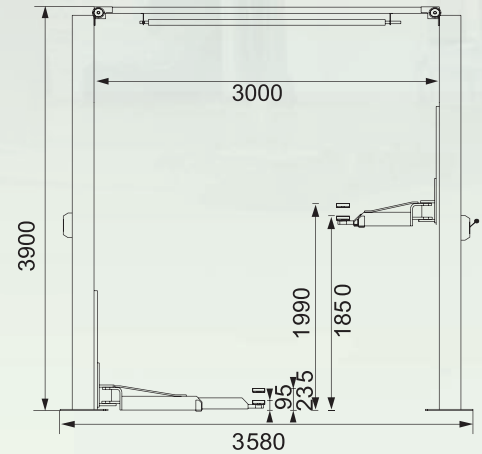

### Features:

- Machine weight is 700KG
- The whole machine passed 1.5 times load test
- The carriage is extended 1950mm, increase the strength
- The slide block in the carriage increase from 2 group to 3 groups to improve the stressed area and stability
- The arm safety lock is designed with bevel teeth to ensure the gear fits tightly
- Aluminum alloy motor, fast heat dissipation
- 24V safety voltage control, more safe operation
- The carriage adopts the welding form of 16mm steel plate, increase the strength
- The cylinder adopt direct drive, avoid risk of chain breaking
- 16pcs M18X160 Expansion bolt
- Designed with 2+3 step straight arm
- Manual unlock with single side
- Standard with adaptor and suitable for SUV vehicle

## AE5103A / AE5103A-3 4T 2 Post Lift Clear Floor



### Technical parameter:

Model	AE5103A	AE5103A-3
Voltage	220V	380V
Capacity	4T	4T
Min. Height	95mm	95mm
Lift Height	1990mm	1990mm
Rise Time	60s	60s
Drop Time	50s	50s
Motor Power	2.2KW	2.2KW
Motor Shell	Aluminum alloy	Aluminum alloy
Machine Height	3760mm	3760mm
Width between column	2860mm	2860mm
Track Width	3440mm	3440mm
Tray Thread	3-step 70mm adjustable	3-step 70mm adjustable
Raised adaptor height	70mm	70mm
Type of arm	2-step straight arm+3-step straight arm	2-step straight arm+3-step straight arm
Electric Control	24V Control box	24V Control box
Fixing hole of floor plate	16pcs	16pcs
Lock Release	Manual unlock with single side	Manual unlock with single side

### Features:

- 24V safety voltage control, more safe operation
- Manual unlock with single side, Auto reset after hand off insurance
- Aluminum alloy motor, fast heat dissipation
- The cylinder adopt direct drive, avoid risk of chain breaking
- Designed with 2+3 step straight arm, suitable for more vehicle model
- 16pcs M18x160mm Expansion bolt
- Standard with adaptor and suitable for SUV vehicle
- The carriage is extended 1950mm, increase the strength
- The slide block in the carriage increase from 2 group to 3 groups to improve the stressed area and stability
- The carriage adopts the welding form of 16mm steel plate, increase the strength
- The arm safety lock is designed with bevel teeth to ensure the gear fits tightly

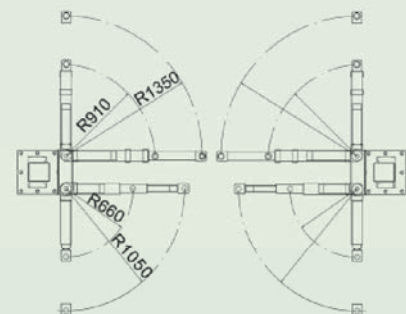
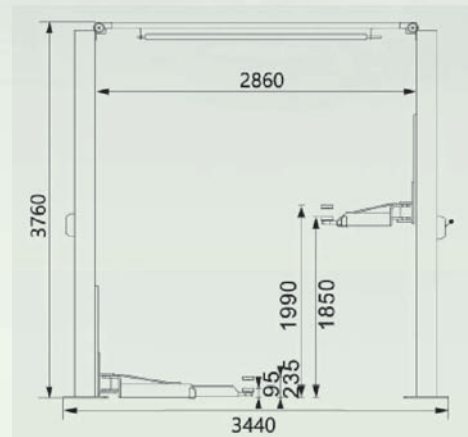

## AE5152 / AE5152-3 4T 2 Post Lift With Electric Control Box



### Technical parameter:

Model	AE5152	AE5152-3
Voltage	220V	380V
Capacity	4T	4T
Min. Lift Height	95mm	95mm
Max. Lift Height	1990mm	1990mm
Rise Time	60S	60S
Drop Time	50S	50S
Motor Power	2.2KW	2.2KW
Motor Shell	Aluminum alloy	Aluminum alloy
Machine Height	3900mm	3900mm
Width between column	3000mm	3000mm
Track Width	3580mm	3580mm
Tray Thread	3-step 70mm Adjustable	3-step 70mm Adjustable
Raised Adaptor height	70mm	70mm
Type of Arm	2-step straight arm+3-step straight arm	2-step straight arm+3-step straight arm
Electric Control	24V Control box	24V Control box
Lock Release	Electric lock release	Electric lock release

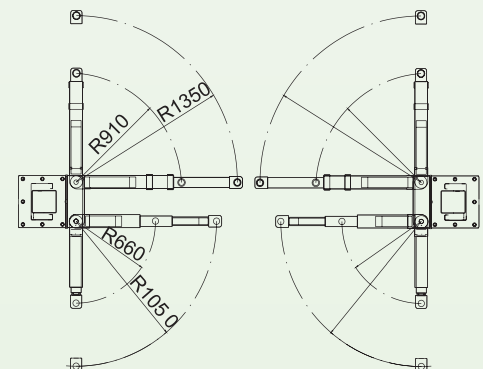
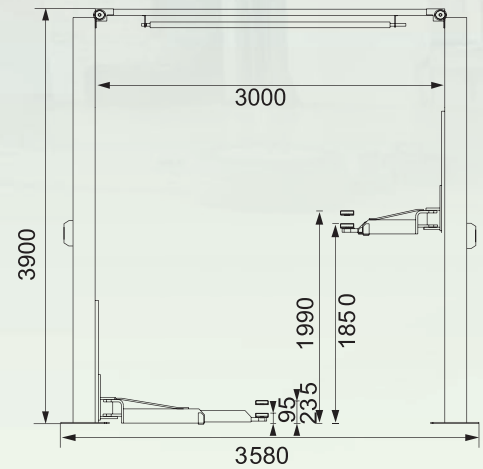

### Features:

- Machine weight is 773KG
- The whole machine passed 1.5 times load test
- The carriage is extended 1950mm, increase the strength
- The slide block in the carriage increase from 2 group to 3 groups to improve the stressed area and stability
- The arm safety lock is designed with bevel teeth to ensure the gear fits tightly
- Aluminum alloy motor, fast heat dissipation
- 24V safety voltage control, more safe operation
- Electric lock release
- The carriage adopts the welding form of 16mm steel plate, increase the strength
- The cylinder adopt direct drive, avoid risk of chain breaking
- 16pcs M18X160 Expansion bolt
- Designed with 2+3 step straight arm
- Standard with adaptor and suitable for SUV vehicle





# B

## Four Wheel Aligner

3D Aligner



11

Intelligent 3D Aligner



12



### AE5602T 3D Aligner

**INTELLIGENT  
PRECISION WITH  
HIGH EFFICIENCY**



#### Technical parameter:

Item	Parameters
Distance from front target plates to camera	1.8m-2.4m
Maximum vehicle wheelbase	3.6m
Vehicle wheel tread range	1.2m-2.3m
Wheel hub dimension range	11"-22"
Adjustable range of the beam height	1820mm-2180mm
Machine warranty	1 year

#### Features:

- New added comprehensive guidance for vehicle adjustment
- New added SATA vehicle adjustment tools set
- Spec data automatic adjustment for modified cars
- Engine bracket adjustment function, engine position location
- Enlarged display mode with graphics and digit after double click the mouse at the interface of screen
- Camera indicator and voice guidance
- Automatic measurement of wheel diameter
- New 3D measurement technology



## AE5603 3D Aligner

# LINKAGE BETWEEN ALIGNER AND LIFT

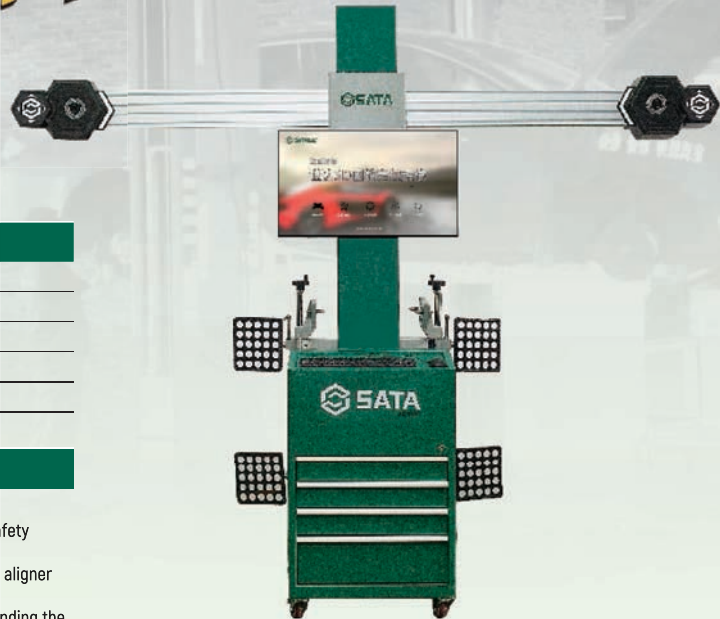

### Technical parameter:

Distance from front target to camera	1.8m-2.4m
Maximum wheelbase	3.60m
Wheel hub dimension range	11"-23"
Adjustable range of beam height	1820mm-2180mm
Machine Warranty	1 year

### Features:

- Linkage between aligner and lift easily controlled by Mouse
- Wheel aligner monitors the horizontal angle of vehicle, and the whole process of safety monitoring and warning
- The software has built-in professional vehicle adjustment function, and four wheel aligner is easy to use
- Exclusive standard with wheel aligner special adjustment set, saving the time for finding the tools.
- Linkage between aligner and lift

## AE5606S Intelligent 3D Aligner



Provide the current status of lift, previous status: Daily, monthly and yearly business statement is clearly.

Enhanced lift linkage control and safety function

Exclusive standard with wheel aligner special adjustment set and tool selection guidance software

# LINKAGE BETWEEN ALIGNER AND LIFT



### Technical parameter:

Exclusive Standard	Intelligent linkage control wheel aligner and auto lift Wheel aligner monitors the safety function of auto lift Updated vehicle alignment set
Intelligent lift connect station	AE5302/AE5302-3 AE5402/AE5402-3
Maximum wheelbase	3.85m
Datebase	30000 (Can upgrade)
Operating system	Win10
Monitor parameter	1080P
Printer	Standard
Warranty period	one year

### Features:

- Monitoring operating status of Lift, Intelligent 3D aligner counts operating times of lift in term of daily, monthly and yearly statement, knowing operation of alignment bay.
- Operating frequency of aligner and lift has been record well. Maintenance in time can lower the risk of Lift.
- Linkage between aligner and lift easily controlled by Mouse
- Innovative folding display, good looking and saving space

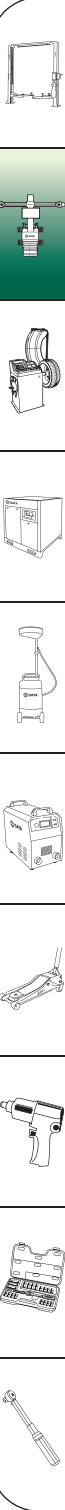

# C

## Tire Equipment & Tool

Tire Changer



13-16

Wheel Balancer



17-19

Tire Inflator



20-21



### AE1021 /AE1021-3 (380V) Swing-Arm Tire Changer

#### Technical parameter:

Out-clamping diameter	11" - 21"
Inside-clamping diameter	13" - 24"
Max. tire width	330mm
Max. tire diameter	39" (1010mm)
Big cylinder force	2100 kgf
Turntable speed	6.5 rpm
Operating air pressure	8-10bar
Noise	≤ 70db
Package size	100x92x100cm
G.W./N.W.	336/294kg
Machine Warranty	1 Year (not including fast moving parts)

#### Features:

- Hollow-carved Logo, Unique and attractive
- Lower bench, easier operation
- Equipped with SATA digital inflator
- Stepping pedal to be able to stop anywhere
- Blade with block avoiding stuck
- Bigger rubber pad, applied to tires with big size.



### AE1021H/AE1021H-3 (380V) Swing -Arm Tire Changer With Helper

#### Technical parameter:

Out-clamping diameter	11" - 21"
Inside-clamping diameter	13" - 24"
Max. tire width	330mm
Max. tire diameter	39" (1010mm)
Big cylinder force	2100 kgf
Turntable speed	6.5 rpm
Operating air pressure	8-10bar
Noise	≤ 70db
Package size	100x92x100cm
G.W./N.W.	278/233kg 282/273kg
Machine Warranty	1 Year (not including fast moving parts)

#### Features:

- Chromed plate, good looking for longer time.
- Reinforced arm for blade, high strength and long lifetime.
- φ80 cylinder for helper, effectively helpful to tire change.
- Steering inlet pressure gauge, easy to monitor real time operating pressure
- Specially designed position structure for swing arm, easy to adjust.
- Aluminum big cylinder equipped with stainless steel quick joint. No rusting.



## AE1022H/AE1022H-3 (380V) Tilt-Tower Tire Changer With Helper

### Technical parameter:

Out-clamping diameter	11" - 21"
Inside-clamping diameter	13" - 24"
Max. tire width	330mm
Max. tire diameter	39" (1010mm)
Big cylinder force	2100 kgf
Turntable speed	6.5 rpm
Operating air pressure	8-10bar
Noise	≤ 70db
Package size	100x92x100cm / 115x52x30cm
G.W./N.W.	336/294Kg 332/290kg
Machine Warranty	1 Year (not including fast moving parts)

### Features:

- Equipped with SATA professional digital inflator
- Bigger rubber pad, applied to tires with big size.
- Lower bench with reinforced rib, High strength
- Helper with sliding bearing, less friction and convenient
- 3+1 pedal, better layout, avoiding mistake
- Aluminum big cylinder equipped with stainless steel quick joint. No rusting.



## AE1023H/AE1023H-3 (380V) Leverless Tilt-Tower Tire Changer

### Technical parameter:

Out-clamping diameter	11" - 24"
Inside-clamping diameter	13" - 26"
Max. tire width	360mm
Max. tire diameter	42" (1080mm)
Big cylinder force	2500 kgf
Turntable speed	6.5 rpm
Operating air pressure	8-10bar
Noise	≤ 70db
Package size	115x105x190cm
G.W./N.W.	371/313kg 367/315kg
Machine Warranty	1 Year (not including fast moving parts)

### Features:

- Equipped with SATA professional digital inflator
- Chromed turntable with big size, applied to low profile tire and run-flat tire
- Helper with sliding bearing, less friction and convenient
- 3+1 pedal, better layout, avoiding mistake
- Specially processed rollover hook, precise, strong and durable.
- Aluminum big cylinder equipped with stainless steel quick joint. No rusting.



## AE1015 /AE1015-3 (380V) Swing Arm Type Tire Changer

### Technical parameter:

Outside clamping distance	10"-21"
Inside clamping distance	12"-24"
Rim width	3"-13"
Max. tire diameter	39" (1010mm)
Pull-push force of large air cylinder	2100kgf
Large plate dimensions	21"
Clamping plate speed	6.5rpm
Withstand pressure of oil-water separator	12kgf/cm2
Operation pressure	8-10bar
Operation noise	<70dB
Package size	1180x920x1100mm
Gross and net weight	275/235kg
Machine warranty	1 year

### Features:

- A model specially designed for avoiding scratching of the steel ring, and for increasing strength of core components such as the enclosure, posts and hexagon bars, which significantly reduces side swinging stroke of the head suffered from forces, thus protect the steel ring. It also reduce enclosure height, making operations easier.

### Product performance:

- Swing arms with classic design, suitable for changing tires for cars
- Reserved mounting hole for suspended auxiliary arm, easy to upgrade
- Alloy steel jaws plus protective cover, effectively avoiding damages to the rim
- Alloy steel head, with a longer life
- Flower type large plate configured with wear pads and scale, assisting in precise alignment
- Chassis stepping function able to stop anywhere, improve the efficiency of clamping
- Stainless steel large air cylinder, strong corrosion resistance
- Rear cover comes standard with quick exhaust valve, increasing the bead breaking efficiency by 1.5 times
- Pressing tire shovel has two adjustable levels, applicable in a wider range
- High pressure oil-water separator with metal protection cover, not damaged easily



Large shovel cover protects tires effectively



Flower type large plates modern and practical

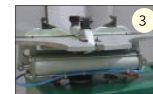

Small air cylinder effectively improve claw speed



Aluminum foot pedals are light, modern and solid

## AE1015H /AE1015H-3 (380V) Single Auxiliary Arm Tire Changer

### Technical parameter:

Outside clamping distance	10"-21"
Inside clamping distance	12"-24"
Rim width	3"-13"
Max. tire diameter	39" (1010mm)
Pull-push force of large air cylinder	2100kgf
Large plate dimensions	21"
Clamping plate speed	6.5rpm
Withstand pressure of oil-water separator	12kgf/cm2
Operation pressure	8-10bar
Operation noise	<70dB
Package size	1180x920x1100mm
Gross and net weight	275/235kg
Machine warranty	1 year

### Features:

- A model specially designed for avoiding scratching of the steel ring, and for increasing strength of core components such as the enclosure, posts and hexagon bars, which significantly reduces side swinging stroke of the head suffered from forces, thus protect the steel ring. It also reduce enclosure height, making operations easier.

### Product performance:

- Suspended auxiliary arms, applicable in a wider range, easy to use
- Alloy steel jaws plus protective cover, effectively avoiding damages
- Alloy steel head, with a longer life
- Flower type large plate configured with wear resistant gasket and scale, aligning precisely
- Chassis stepping function enables to stop anywhere, improving the efficiency of clamping
- Stainless steel large air cylinder, highly resistant to corrosion
- Rear cover comes standard with quick exhaust valve, increasing 1.5 time of bead breaking efficiently
- Bead breaker has two adjustable levels, applicable in a wider range
- High pressure oil-water separator with metal protection cover, not easily damaged

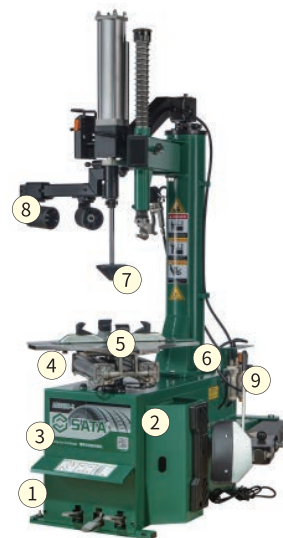

Aluminum foot pedals are light, modern and solid



Large shovel cover protects tires effectively



Small air cylinder effectively improve claw speed

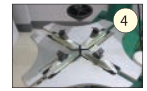

Flower type large plates modern and practical



Large plate scale, aligning precisely



Reinforced post bases



Pads specially for the head, safe to use

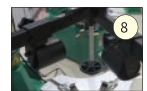

Double roller design



High pressure oil-water separator



## AE1018H /AE1018H-3 (380V) Luxury Crowbar-free Tire Changer

### Technical parameter:

Applicable hub diameter	11"-26"
Max tire diameter	1100mm
Rim Width	3"-14"
Operation pressure	8-10bar
Pull-push force of large air cylinder	2800kgf
Operation noise	70db
Rotating speed	6.5/13rpm
Machine Size	2200x1950x2250mm
Gross and Net weight	300/375kgs
Machine warranty	1 year

### Features:

- The new crowbar-free module makes the disassembly and assembly of flat tires and explosion-proof tires easier and more efficient.

### Product performance:

- The new crowbar-free module makes the disassembly and assembly of flat tires and explosion-proof tires easier and more efficient
- Strengthen the box body, add reinforcement ribs on the base, and the front end is closed, and the column is not easy to deform when disassembling and installing the tire
- With a 380V two-speed motor, tire disassembly is more efficient. It is suitable for maintenance shops where high-quality tires are frequently replaced
- SATA exclusive front cover and base cover, product appearance upgrade
- With a new type of manual valve control, the hexagonal axis runs smoothly, and the operation is comfortable
- 200mm stainless steel cylinder, more powerful shoveling force, suitable for all kinds of hard-walled tires, explosion-proof tires
- The column adopts a 5mm steel plate double bending mechanism, which has high strength, and the tire will not be deformed when disassembling and installing, which protects the safety of the tire and rim

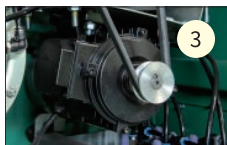
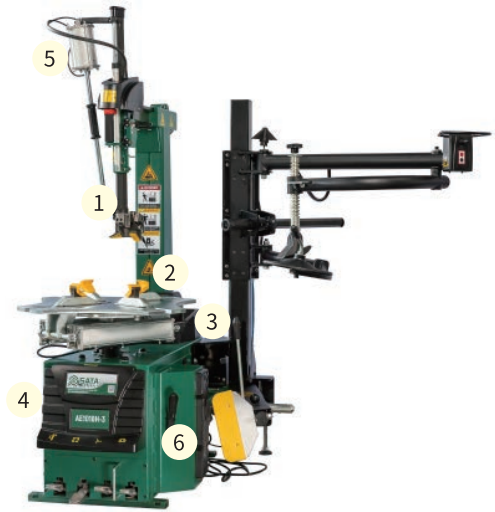

## AE2011 Economic Wheel Balancer

### Technical parameter:

Rated voltage	220V, 50Hz
Rim diameter	10"-24"
Rim width	1.5-20"
Balancing precision	±1g
Balance time	7s (20kg wheels)
Gross/Net weight	144/121 kg
Max. wheel weight	65 kg
Operating noise	≤69dB
Operating temperature	0°C-50°C
Wheel diameter limit	44"
Motor power	250W
Relative humidity	≤85%
Machine warranty	1 year

### Features:

- Stable system with high precise drive system and high performance components
- 3 types of counterweight aligning modes and motorcycle tires balancing mode
- High performance motor with low noise, improving durability of the entire unit



Normal Mount



Reverse Mount



Practical lead hood, easy to access



Tape with HD scales

#### Tips:

- Normal mount: mainly applied to ordinary steel rims and aluminum alloy rims. This mode is suitable for small deformed rims
- Inverse mount: suitable for steel rims and aluminum alloy rims. Especially it has high precision for the rims deformed much on the outside or thicker aluminum rims. (This mode is preferred)



## AE2015 Precision Wheel Balancer

### Technical parameter:

Rated voltage	100-230V, 50Hz
Rim diameter	1"-28"
Rim width	1.5"-20"
Max. tire diameter	39" (1118mm)
Max. tire weight	70kg
Balancing precision	±1g
Balancing cycle	7s
Drive shaft diameter	40mm
Extended drive shaft	300mm
Energy-saving motor	90W
Rotation speed	140 rpm
Operation noise	<70dB
Tire type	Car, motorcycle, SUV
Balancing mode	Dynamic balancing, static balancing ALU1 ~ ALU5, ALS1, ALS2
Package size	990x760x1150mm
Gross and net weight	166/129kg
Machine warranty	2 year

### Features:

- A wheel balancer with special design, high precision and great stability, suitable for large-diameter and wider tires.
- Italy software, imported elements and circuit boards, advanced design, with 7 aluminum rims balancing modes, 2 custom balancing modes, motorcycle balancing mode (requiring optional clamp), SUV balancing mode
- Manual aligning combined with foot brake
- Energy-saving mode, automatic dormancy status after 5 minutes of stopping using
- Optimized rim matching mode; unbalance decomposition and hiding feature
- Special designed tray, convenient to place balance weights and tools

**STRONG APPLICABILITY  
HIGH EFFICIENCY**

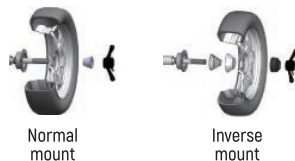

Normal mount

Inverse mount

#### Tips

- Normal mount: mainly applied to ordinary steel rims and aluminum alloy rims. This mode is suitable for small deformed rims.
- Inverse mount: suitable for steel rims and aluminum alloy rims, especially it has high precision for the rims deformed much on the outside or thicker aluminum rims. (this mode is preferred)



Easy-to-use display



Sata unique tray for balance weights



LED lights



Reinforced drive shaft, highly stable, ultra long drive shaft, suitable for widen tires



Convenient attachment hooks



## AE2016 Automatic Wheel Balancer

### Technical parameter:

Rated voltage	100-230V, 50Hz
Rim diameter	1"-28"
Rim width	1.5"-20"
Max. tire diameter	39" (1118mm)
Max. tire weight	70kg
Balancing precision	±1g
Balancing cycle	7s
Drive shaft diameter	40mm
Extended drive shaft	300mm
Energy-saving motor	90W
Rotation speed	140 rpm
Operation noise	<70dB
Tire type	Car, motorcycle, SUV
Balancing mode	Dynamic balancing, static balancing ALU1 ~ ALU5, ALS1, ALS2
Package size	990x760x1150mm
Gross and net weight	166/129kg
Machine warranty	2 year

### Features:

- A wheel balancer with special design, high precision and great stability, suitable for large-diameter and wider tires
- Italy software, imported elements and circuit boards, with advanced design
- LED operating display; automatic measurement of input distance, rim diameter parameters and rim width, realizing automatic measurement input of 3 groups of data
- 7 aluminum rims balancing modes, 2 custom balancing modes, motorcycle balancing mode (requiring optional clamp), SUV balancing mode
- Automatic aligning combined with electromagnetic brake
- Energy-saving mode, automatic dormancy status after 5 minutes of stopping using
- Optimized rim matching mode; unbalance decomposition and hiding feature
- Reinforced drive shaft, highly stable, ultra long drive shaft, suitable for wider tires
- Special designed tray, convenient to place balance weights and tools

**AUTOMATIC MEASUREMENT  
AND POSITIONING**



Normal mount



Inverse mount

#### Tips

- Normal mount: mainly applied to ordinary steel rims and aluminum alloy rims. This mode is suitable for small deformed rims.
- Inverse mount: suitable for steel rims and aluminum alloy rims, especially it has high precision for the rims deformed much on the outside or thicker aluminum rims. (this mode is preferred)



Easy-to-use display



Sata unique tray for balance weights



LED lights



Reinforced drive shaft, highly stable, ultra long drive shaft, suitable for wider tires



Convenient attachment hooks

## AE2021 Economic Wheel Balancer

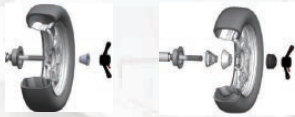

Normal Mount

Reverse Mount

**Tips:**

- Normal mount: maily applied to ordinary steel rims and aluminum alloy rims. This mode is suitable for small deformed rims
- Inverse mount: suitable for steel rims and aluminum alloy rims. Especailly it has high precision for the rims deformed much on the outside or thicker aluminum rims. (This mode is preferred)

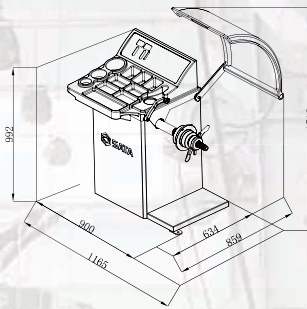

### Technical parameter:

Rim diameter	10"-30"
Rim width	1.5-20"
Max. tire weight	65Kg
Balance precision	±1g
Balance period	7s (20Kg wheel)
Input voltage	220V, single phase
Motor power	250 W
Noise	≤70dB
Package size	97x77x115cm
G.W./N.W.	110/81Kg
Machine Warranty	1 year

### Features:

- Rational molding weight cover with high durability.
- Key board with better layout and good looking
- Equipped with high quality SATA balance hammer
- High precision drive system with more stability.
- Tire cover rack moved forward to save space

## AE2022 Precision Wheel Balancer

### Technical parameter:

Rated voltage	220V/50HZ
Rim diameter	10"---26"
Max. tire width range	415mm
Max. tire diameter range	1080mm
Balance precision	±1g
Balance speed	140-160 RPM
Balance period	7S (20Kg wheel)
Max. tire weight	70Kg
Maglev motor power	DC 48V/200W
Noise	70db
Maximum space size	1120*750*1550mm ±10mm
Package size	970*770*1150mm
N.W./G.W.	92/117kgs

### Features:

- Magnetic levitation drive module, which reduces motor and belt vibration compared to motor drive
- 512 angular position measurement, find imbalance point more accurate, balance more accurate
- Measure distance and diameter automatically, find points and lock automatically
- Self-excited electromagnetic brake, no vulnerable components, to ensure the reliability of the machine and low failure rate
- LED display, data is clearly visible



**98101 Dial Tire Inflation Gun**



Measurement range	0-8 bar/117 psi
Reading accuracy	0.1 bar
Precision	JJG 875 Standard Grade 1.6, Max. range 90-100%, error ± 2.5%, measuring range error is ± 1.6%
Max. inlet pressure	15 bar/218 psi
Outline dimension	315 x 100 x 170 mm
Weight	0.95 kg
Warranty period	6 months

- The measurement range is specially designed for passenger cars, with scales displayed clearer
- High-precision mechanical pressure gauge, with better stable performance
- Aluminum body with rubber sheath, better shockproof and impact-proof performance
- Stainless steel braided hose, resistant to bending with longer life
- Copper intake connector, rust-proof and durable

**98103 Digital Tire Inflation Gun**



Measurement range	0-12 bar/174 psi
Reading accuracy	0.01 bar/0.1 psi
Precision	Tolerance for measurement 0.5-6 bar: JJG875 Standard Grade 0.2; 6-10 bar: JJG875 Standard Grade 0.5
Max. inlet pressure	15 bar/218 psi
Outline dimension	315 x 100 x 170 mm
Weight	0.95 kg
Warranty period	6 months

- LCD display with backlight, which is clearer
- Aluminum body with rubber sheath, better shockproof and impact-proof performance
- Stainless steel braided hose, resistant to bending with longer life
- Copper intake connector, rust-proof and durable

**98105 Automatic Tire Inflator**



Measurement range	0-10 bar/145 psi
Reading accuracy	0.01 bar/0.1 psi
Precision	Tolerance for measurement 0.5-6 bar: JJG875 Standard Grade 0.2; 6-10 bar: JJG875 Standard Grade 0.5
Max. inlet pressure	10.5 bar/152 psi
Power consumption	MAX 12 W
Outline dimension	310 x 300 x 220 mm
Operating temperature	-10°C-50°C
Warranty period	6 months

- Automatic inflation, easy to operate and comes with a reminder
- Imported high precision ceramic sensors, ensuring accurate tire pressure
- Aluminum cast body has a modern look, light-weighted and durable
- New tyre inflation function, helping tires to get closer to the hub

**98107 Column Tire Inflator**

- High accuracy, built-in high-precision ceramic sensor
- Clear reading, specially designed large-screen LCD display
- The inflatable tube adopts a 10-meter hose reel, which can shrink freely
- Stylish appearance, built-in LED white light-emitting tube
- Standard with air-water separator to ensure the quality of air source



Model	Inflation range [BAR]	Accuracy [BAR]	Max Inlet Press [BAR]	Hose Length[MM]	Hose I.D./O.D. [MM]	N.W. [KG]	G.W. [KG]
98107	0.5-10	0.01	10.5	10	Ø6.5/Ø10	25.2	28

**98104 Exquisite Digital Tire Inflation Gun**

- Cast aluminum body with shock-absorbing protective cover
- There are three units of PSI, BAR, KPA to choose from
- Three-in-one function, can be used to inflate, deflate and measure tire pressure
- The metal spring sheath protects the hose and prevents the hose from entanglement

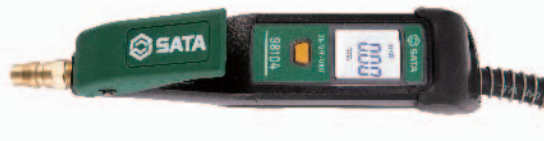

2pcs AAA Battery

Model	Reading accuracy	Digital display meter range	Max Intake pressure	Product accuracy	Work Temperature
98104	0.01Bar (0.1Psi)	0-12Bar (174Psi)	15 Bar/219 Psi	JBT0.3 Level	-10°C-60°C

**AE5851 Pneumatic Tire Spreader**

- Step foot, can stop at any position
- Machine box plate thickness 2.0mm
- Classic work lamp, effectively accelerate vulcanization time
- Cool exterior, built-in LED white light source
- With oil-water separator, prolong cylinder life



Model	Tire Width (MM)	Pressure (BAR)	Voltage (V)	Power (W)	Working temperature (°C)	N.W (KG)	G.W (KG)
AE5851	145-275	6-10	12V/AC220	55	-10°C— 60°C	59	72

## AE5806 Intelligent Battery Charger

### Features:

- Comparing with traditional type, charging with 9-section changing current is less harmful to battery. More efficient and energy-saving.
- The design of intelligent and integrated control makes operation easier. The whole process need setting once.
- The function repairing battery prolongs battery lifetime
- Applying to different vehicle batteries including new type start-stop battery GEL and AGM.



Model	Power Voltage	Frequency	Power	Output Voltage	Output current	Continuous Emergency Starting Current	N.W./G.W.	Package Size
AE5806	220V	50Hz	800W	DC 12/24V	2/10/40A (12V)	180A(12V)	24/26kg	545x545x640mm
					2/10/20A (24V)			

## AE5808 Portable Battery Charger

### Features:

- The design of intelligent and integrated control, comparing with traditional charger with manual selection, is more intelligent and convenient. The whole process need setting once.
- Comparing with traditional type, 7-section changing current charges battery more, More efficient and energy-saving.
- Small size, portable
- LED display switching voltage, current and power.
- Applying to different vehicle batteries including new type start-stop battery GEL and AGM.



Model	Power Voltage	Frequency	Power	Output Voltage	Output current	N.W./G.W.	Package Size
AE5808	220V	50Hz	240W	DC12/24V	2/10/20A (12V)	1.5/1.7kg	276x155x122mm
					2/10A (24V)		

## AE5721 12V Emergency Power with Jumper Starter

### Features:

- 400A Peak Start Current
- Real Capacity, no overstatement
- Three lighting Modes apply to emergency rescue.
- High-performance cell can start in low power
- Smart battery clip with multiple protection.



Power charger



Car charger



Smart Battery Clip



Data line

Model	Capacity	Input Voltage	Start Current	Peak Current	N.W.	Size	Warranty
AE5721	10000mAh	15V/1A	200A	400A	0.5Kg	25x20x8cm	12 Month

## AE5723 12V Emergency Power with Jumper Starter

### Features:

- 600A Peak Current can start Diesel and Gasoline Car
- 16000mAh with high capacity cell
- HD Screen with power showed intelligently
- Three lighting Modes apply to emergency rescue
- 7-Section Safety Protection



Power charger



Car charger



Smart Battery Clip





Data line

Model	Capacity	Input Voltage	Start Current	Peak Current	N.W.	Size	Warranty
AE5723	16000mAh	15V/1A	400A	600A	0.5Kg	25x20x8cm	12 Month



# D Air Compressor

Air Compressor	 23-24
Air Dryer	 25
Precise Filter	 25



## Piston Air Compressor

- More durable air valve design
- High strength aluminum alloy structure body
- The motor provides reliable power, low-voltage startup performance is excellent

- The powerful fan cooling system
- Special Shockproof design
- Standard equipment for pressure regulating valve and oil-water separator



AE5801



AE5802



AE5803

Model	Cooling	Exhaust volume (m <sup>3</sup> /MIN)	Exhaust pressure (Mpa)	Gas storage (L)	Power(KW)	Diameter*Quantity of air tank(MM)	Route(MM)	Size (LxWxH) CM
AE5801	Air cooling	0.25	0.8	100	2.2	65×2	46	105×43×76
AE5802	Air cooling	0.48	0.8	125	4	90×2	60	126×43×86
AE5803	Air cooling	0.9	0.8	190	7.5	90×3	70	144×49×93

## Screw Air Compressor

- High energy-efficient main motor
- Stable intake valves system
- External rotary oil filter design, easy for

- maintenance
- Low noise, small size and high energy-efficient



AE5811



AE5812



AE5813

Model	Cooling	Exhaust volume (m <sup>3</sup> /MIN)	Exhaust pressure(Mpa)	Noise(DB)	Motor			Size (LxWxH) CM	净重KG
					Power(KW)	RPM	Start Model		
AE5811	Air cooling	1.0	0.8	70-72±2	7.5	2945	Direct start	80×65×87	195
AE5812	Air cooling	1.6	0.8	70-72±2	11	2945	Star triangle	85×81×97	280
AE5813	Air cooling	2.1	0.8	70-72±2	15	2945	Star triangle	85×81×97	295

## AE5818 Four-in-one Air Compressor



- Integrate screw air compressors, air dryers, precision filters and air storage tanks into one
- Plug and then use at once, simple operation, convenient and quick
- Complete air supply system, no connecting pipeline installation cost, users can use high-quality compressed air after connecting to the power supply
- Install universal wheels and fixed wheels for easy movement

Rated voltage	Exhaust volume/ Exhaust pressure	Drive motor power	Drive mode	Motor drive mode	Cooling	Tank volume	Air outlet spec.	Noise	Machine Size	N.W.
Air dryer 220V/50HZ										
Screw air compressor 380V/50HZ	1.0m <sup>3</sup> /min; 8bar	7.5kw	Belt drive	Start directly	Air cooling	340L	Rc3/4"	70-72dB(A)	1745*850*1580mm	395kg

## Air Compressor(Oil-less slient)



AE5903/AE5903-3



AE5904/AE5904-3

- Compact body, high efficiency, energy saving, quiet and environmental protection
- The leather wrist is made of new environmental protection material, with low friction coefficient, self-lubricating and prolonging service life
- No oil lubrication, no secondary pollution to the air source and widely used
- The cylinder liner uses surface anodes to reduce thickness and coefficient of friction and accelerate heat dissipation
- The intake and exhaust valve plates are made of imported materials and processed by a special process, with a silencing design and lower noise

Model	Rated voltage	Exhaust volume/ Exhaust pressure	Drive motor power	Drive model	Motor drive mode	Cooling	Tank volume	Air outlet spec.	Noise	Machine Size	N.W.
AE5903	220V/50Hz	0.38m <sup>3</sup> /min; 8bar	3.3kw	Direct connection	Delay start	Air cooling	110L	Rc1/2" 1/4"	≤85 dB(A)	1220*350*810mm	97kg
AE5903-3	380V/50Hz	0.38m <sup>3</sup> /min; 8bar	3.3kw	Direct connection	Delay start	Air cooling	110L	Rc1/2" 1/4"	≤85 dB(A)	1220*350*810mm	97kg
AE5904	220V/50Hz	0.49m <sup>3</sup> /min; 8bar	4.4kw	Direct connection	Delay start	Air cooling	180L	Rc1/2" 1/4"	≤85 dB(A)	1440*450*850mm	134kg
AE5904-3	380V/50Hz	0.49m <sup>3</sup> /min; 8bar	4.4kw	Direct connection	Delay start	Air cooling	180L	Rc1/2" 1/4"	≤85 dB(A)	1440*450*850mm	134kg





## Air Dryer & Precise Filter

### Features:

- Built-in more power refrigerating compressor and radiator system, enhance the condensing water ability
- With time control function, you can set the time to start or stop the machine according to the working time, that can save more energy of garage
- Built-in electronic automatic drain valve, easy to operate

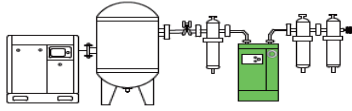

AE5881



AE5882



AE5883

### Technical Parameter:

Model	AE5881	AE5822	AE5883
Apply to air compressor model	AE5811	AE5812	AE5813
Air capacity m <sup>3</sup> /min	1.5	2	2.5
Intake air temperature Cooling method	Air cooling	Air cooling	Air cooling
Environment temperature	10-45°C	10-45°C	10-45°C
Press dew point	2-10°C	2-10°C	2-10°C
Refrigerant	R22	R22	R22
Refrigerant consumption(g)	400	500	600
Intake air pressure Pressure loss	≤0.8MPa	≤0.8MPa	≤0.8MPa
Power supply	AC1-220-50Hz	AC1-220-50Hz	AC1-220-50Hz
Compression power(KW)	0.75	0.75	0.87
Fan power (W)	90	100	100
Hole diameter of air pipe	Rc 1"	Rc 1"	Rc 1.5"
Size L*W*H Mm	700x420x710	700x420x710	700x420x710
Machine weight(kg)	65	65	75

## Precise Filter



### Features:

- With automatic mechanical drain valve, the failure rate is low
- Adopting multi-layer glass fiber filter element with strong oil and dust removal ability
- High temperature resistance of 65 degrees, strong durability
- Label reminder to avoid wrong installation

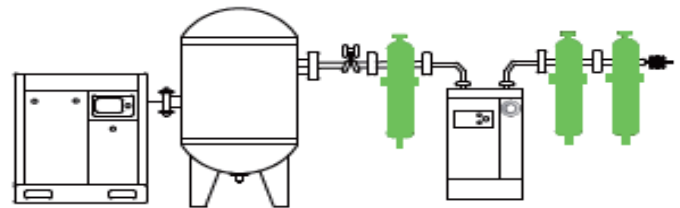

Model	Applicable screw machine model	Diameter of joint	Air capacity	Diameter of water outlet	Filtering precision	Rated pressure	Intake air temperature	Separation principle	Product Size
AE5896Q	AE5811	Rp0.75"	1.5m <sup>3</sup> /min	Rc1/2"	Solid particle 3μm	≤0.8MPa	≤65°C	Multi-layer filtration	160*108*412mm
AE5896P	AE5811				oil content 5PPM				
AE5896S	AE5811				oil content 1PPM				
AE5897Q	AE5812/AE5813	Rp1.5"	2.4m <sup>3</sup> /min	Rc1/2"	Solid particle 0.01μm	≤0.8MPa	≤65°C	Multi-layer filtration	165*108*480mm
AE5897P	AE5812/AE5813				oil content 5PPM				
AE5897S	AE5812/AE5813				oil content 1PPM				
AE5897S	AE5812/AE5813				Solid particle 0.01μm				oil content 0.01PPM



<b>Oil and Liquid Equipment</b>	
Waste Oil Collector	26-27
Oil Changer	28
Accessory	29



Waste Oil Collector

*Inflating 3 minutes using a full day*



AE5701  
Waste oil collector  
(with measuring glass)



AE5702  
Waste oil collector  
(without measuring glass)



AE5704  
Waste oil collector  
(Without measuring glass)

No	AE5701	AE5702	AE5704
Ultimate vacuum	>-0.8BAR	>-0.8BAR	-
Oil tank	70L	70L	70L
Measuring glass	10L	-	-
Drainage radius	294MM	294MM	294MM
Air source	8-10BAR	8-10BAR	-
Overall height	1721MM	1721MM	1721MM
Package	carton	carton	carton
Machine warranty	1 year	1 year	1 year
Vacuum degree reaches 0.85bar, extraction speed up to 3L/min	•	•	◦
Air-/oil circuit separated, no mutual interference	•	◦	◦
After reaching the vacuum degree, disconnect the air source, to extract 50L oil continuously (about 10 cars)	•	◦	◦
Equipped with safety valve, if misoperation occurs, the safety valve will discharge immediately, protecting the measuring glass from being damaged by high pressure	•	◦	◦
Eccentric oil tray, increasing collecting range	•	•	•
Armrest sleeve, comfortable	•	•	•
Bearing roller, durable	•	•	•
Two-section extension rod, providing better sealing	•	•	•
SATA designed tool tray, easy for tool collection	•	•	•
Automatic welding, with stable and reliable quality	•	•	•
Ergonomic handle, comfortable to use	•	•	◦

• Equipped with this feature ◦ Without this feature



Waste Oil Collector



AE5705  
Waste Oil Collector

AE5706  
Waste Oil Collector

AE5707  
Waste Oil Collector(with  
measuring glass)

AE5708  
Waste Oil Collector(Double-pumping with  
measuring glass)

Model	AE5705	AE5706	AE5707	AE5708
Ultimate vacuum	-0.8bar	-0.8bar	-0.8bar	-0.8bar
Oil tank	70L	70L	70L	70L
Measuring glass	-	-	9L	9L
Drainage radius	325mm	325mm	325mm	325mm
Air source	8bar	8bar	8bar	8bar
Overall height	1150-1660mm	1150-1660mm	1150-1660mm	1150-1660mm
Oil absorption speed	1.5-2L/min	1.5-2L/min	1.5-2L/min	1.5-2L/min
Suction pipe length	φ5"750/φ6"750/φ6"970/ φ8"750 2pc nylon pipe	φ5"750/φ6"750/φ6"970/ φ8"750 2pc nylon pipe	φ5"750/φ6"750/φ6"970/ φ8"750 2pc nylon pipe	φ5"750/φ6"750/φ6"970/ φ8"750 2pc nylon pipe
Oil drain pipe length	1.6m	1.6m	1.6m	1.6m
Minimum oil diameter range	φ410	φ410	φ410	φ410
Packing	Carton	Carton	Carton	Carton
Whole machine warranty	one year	one year	one year	one year
Vacuum degree 0.8bar, fast pumping speed	○	●	●	●
Forget to close the valve, directly flush the positive pressure gas, the system automatically isolates and protects the measuring cup	○	○	●	●
The eccentric design of the oil collector, the oil receiving range is much higher than the concentric design oil pan	●	●	●	●
Roller with bearing, durable	●	●	●	●
Configure tool tray for convenient tool placement	●	●	●	●
The surface welds are full, no false welding spatter, and the surface is rust-proof and sprayed	●	●	●	●
Vacuum the measuring cup separately	○	○	●	●
The safety valve opens at 1.5 bar when draining oil	●	●	●	●
Vacuum noise≤85db	●	●	●	●

● Indicates equipped with this function ○ Indicates no this function

**Automatic transmission oil replacement connector (8PCS)**



No.	Dimension MM (L×W×H)
AE5753	600×400×150

**AE5752 Touch Screen AT Oil Changer**



Operating Temperature	-10°C~40°C
Replace tolerance	±150-200ml
Relative Humidity	<85%
Voltage	DC12V
Max. Power	120W
Pressure gauge	0~150psi
Touch screen size	10"
Filter Precision	5um
Length of outlet pipe	2.25m
Length of return pipe	2.25m
Length of Drain pipe	1.5m
Oil Tank	20L*2
Noise	<70db
Net weight	60KG ±1KG

- 10.1 inch capacitive touch screen display, convenient and practical.
- Automatic model oil change guide function, model data is complete
- Replace the result printing function.
- Automatically recognizing oil outlet or inlet/ Intelligent switch between oil outlet and inlet
- Old and new oil lamps with time indication, more visual.
- Electronic scales are zeroed at the touch of a button, the operation is smarter.
- Zero pressure oil change, more powerful.
- The fuel pressure of the transmission radiator is visually displayed.

**AE5775 Cooling liquid changer**



Operating Temperature	-10°C~+40°C
Relative Humidity	<85%
Pressure gauge	0-10kg
Length of fill the recycling pipe	2.25m
Length of clean the drain pipe	2.25m
Filter Precision	5um
Noise	<70db
Max. Power	180W
Net weight	46kg ±1KG

- Large cycle cleaning replacement function
- The contrast between old and new antifreeze is obvious.
- Filling speed adjustment function.
- 5um filtration system for automatic elimination of cooling system bubbles.
- A full set of European car connectors, a wide range of applications.

**AE5751 AT Oil Changer**



Operating Temperature	-10°C~40°C
Relative Humidity	<85%
Voltage	DC12V
Max. Power	120W
Pressure gauge	0~150psi
Replace tolerance	±150-200ml
Length of outlet pipe	2.25m
Length of return pipe	2.25m
Length of Drain pipe	1.5m
Oil Tank	20L*2
Filter Precision	5um
Noise	<70db
Net weight	60KG ±1KG

- Automatically recognizing oil outlet or inlet/ Intelligent switch between oil outlet and inlet
- Old and new oil lamps with time indication, more visual.
- Zero pressure oil change, more powerful.
- Electronic scales are zeroed at the touch of a button, the operation is smarter.
- The fuel pressure of the transmission radiator is visually displayed.

**AE5771 Brake Oil Changer**



Capacity	4L
Power	120W
Speed	3L/min
Voltage	DC12V
Pressure	0-0.4Mpa(4bar)
Weight	45KG ±1KG

- Fill with new oil, four wheels at the same time to recover old oil.
- Standard with car model connector
- Compared with old and new brake fluids, the alarm is stopped when the level is low, and the operation is more safe.
- Electric oppression work, 2-3 minutes completely replaced, pressure can be adjusted.
- The filling pressure can be pre-set to prevent damage to the main pump jug.



**AE5760** Thin oil filling kit



**Technical parameter:**

Cart Capacity	180KG-220KG
Pump compression ratio	3:1
Pump working pressure	5-8bar
Maximum pump oil pressure	<24bar
Pump air consumption	100L/min
Pump output oil volume	<18L/min
Pump suction pump diameter	42mm
Pneumatic oil pump noise	≤90dB(A)
Flow range of filling gun	1-35L/min
Accuracy arrange of filling gun	±0.3%
Preset the range of filling gun	0.1-99.9L
Min.oil pressure of filling gun	1bar
Max.oil pressure of filling gun	67bar
Filling gun pipe	Fully automatic stainless steel nozzle

**Features:**

- Pre-set digital display fueling gun, accurate measurement ( $\pm 3\%$ ), automatic shutdown when the fueling volume reaches the set value, humanized design. Adopting new structure and sealing method, new design of drip-proof automatic opening and closing nozzle
- Pneumatic oil pump, with high output pressure, equipped with oil-water separator, can control the oil output speed, and filter the water in the compressed air at the same time, prevent rust and increase the service life. At the same time, it is equipped with a regulator bottle to reduce the jitter of the gun body.
- The hose is made of special synthetic rubber, which has excellent oil resistance, heat resistance and aging resistance.
- This product is safe, high-efficiency, easy to operate, and suitable for large-volume users. Replace the traditional way of refueling via small bottles, saving costs and improving work efficiency

**AE5741** Two-way refrigerant gauge set



Refrigerant	R134a
Pressure units	psi/bar
Temperature unit	°C
Thread	1/4"SAE

- Pressure detection and manifold detection pressure

**AE5742** Adjustable quick connector set



Suitable for R134a connections	
Main thread	M14x1.5
Connecting thread	1/4" SAE*M14X1.5

- Quick connection





**AE5743** Tricolor refrigerant tube 1.5M



Thread	yellow tube 1/4"SAE*1/4"SAE
Red/Blue tube	1/4" SAE*M14X1.5
Pressure	600-3000psi
Length	1.5M

- Safe and explosion-proof, strong and durable

# Other Auto Maintenance Equipment

Body Repair Machine		30
CO2 Shield Welding Machine		31
Refrigerant recovery and filling machine		31
Cleaning Machine		32
Hose Reel Set		33



## AE7002 Intelligent Car Body Repair Machine



### Features:

- Equipped with intelligent system, which recommends parameter after function selection. Easy operation.
- With switch of Automatic/Manual realize output automatic, Output can be auto-induced in automatic model, Easy operation
- Equipped with meson generator, greatly improving implanting rate of meson piece. More efficient repair.

Model	Input Voltage	Max. Input Current	Max. Output Current	Output Power	Air Switch	Input Cable	Package Size	N.W./G.W.
AE7002	380V 3PH	80A	3000A	12KVA	≥ 32A	≥4mm	51*34*30cm	32/35kg

## AE7004 Aluminum Car Body Repair Machine



### Features:

- Being with capacitance of 90000UF, more powerful and higher success rate of implanting nail.
- Equipped with intelligent control system. Parameter match can be finished just by adjusting knob. Easier operation.
- Being with SCR quick discharge, higher implanting speed and repair efficiency.

Model	Input Voltage	Max. Inrush Input Current	Max. Capacitance	Output Power	Air Switch	Input Cable	Package Size	N.W./G.W.
AE7004	220V 1PH	17A	90000UF	1458KVA	≥25A	≥1.5mm	66*28*39cm	32/36kg



**AE7021-3** CO2 Shield Welding Machine



**Features:**

- Equipped with precise control system, being able to weld steel plate with thickness of 0.4mm. More application
- Stable globular transfer, few splash, Better looking of welding line.
- Famous brand welding gun, good quality and more durable

Model	Input Voltage	Input Power	Output Current	Output Power	Air Switch	Input Cable	Package Size	N.W./G.W.
AE7021-3	380V 3PH	6KW	6-180A	3.5KVA	≥25A	≥2.5mm	89*36*61.5cm	58/63kg

**AE7022** Aluminum-Iron Double Gun Welding Machine



**Features:**

- Invert technology adopted, Smaller Size and less weight, saving storage space
- Stable globular transfer, few splash, Better looking of welding line.
- Equipped with double gun with switch for steel and Aluminum, decreasing user cost effectively.

Model	Input Voltage	Input Power	Output Current	Output Power	Air Switch	Input Cable	Package Size	N.W./G.W.
AE7022	220V 1PH	8.25KVA	8-210A	4.8KVA	≥32A	≥2.5mm	89*33*75cm	58/64kg

**AE5732** Automatic refrigerant recovery and filling machine



**Technical parameter:**

Refrigerant	HFC-R134a
Capacity	10kg
Electronic scale	10g-50kg
Voltage	220V 50Hz/60Hz
Condenser spec.	21*21*5.5cm Double row
Dimensions	1185*653*485mm
Compressor Power	1/4 HP (Imported compressor)
Pumping speed	≥60L/min
Net Weight	70kg

**Features:**

- Fully automatic functions: recovery, regeneration, vacuuming, filling of refrigerant/refrigerated oil, draining waste oil, replenishing refrigerant, leak detection, no manual valve operation required
- Automatic oil drain
- Automatic oil filling
- Visual and audible alarm: the user will be reminded when the operation is completed or there is a problem, and it can be monitored from a distance
- Leak detection: after recovery and vacuuming, it will detect leaks
- Automatic exhaust: Automatic removal of excess gas from the system without additional pressure gauge monitoring or manual valve operation
- Vacuuming: The system displays the remaining vacuum time
- Refrigerant supplementation: the user can choose the amount of supplement
- Refrigerant filling: You can choose to fill from the low-pressure end or from both ends together
- Refrigerant management system: the system can set the drying bottle replacement time (every 200 hours)

**AE5736 Dry Ice Cleaner**



**Technical parameter:**

Voltage	220V 50Hz
Power	500W
Pressure range	0.4-1Mpa
The size of the external tube	≥ 1/2 Inch tube
Working material	3mm Granular dry ice
Volume	12.5L
Dimension	550*530*1140mm
Dry ice consumption	0.3-1.3kg/min
External air source pressure	Min≥0.4Mpa
Air consumption	0.8-3.7m <sup>3</sup> /min
Net Weight	68kg

**Features:**

- The operation is simple and the machine does not need to be removed or reassembled
- No wear, non-flammable, non-conductive
- Narrow spaces that can be cleaned by many other methods that cannot be cleaned
- Visual operating system, customer experience is good
- It can be used to clean the combustion chamber of the car engine, the carbon build-up of the intake valve, the engine compartment and the chassis, wheels and other parts of the hard to remove dirt



**AE5901 Smog leak detector**



**Technical parameter:**

Rated Voltage(V)	12
Rated Current(A)	6
Maximum working pressure(psi/bar)	17.5psi/1.2bar
Max. Flow	8L/min
Operation Cycle	5min/cycle
Dimension	240X195X240mm
Net Weight	4kg

**Features:**

- Wide application, being able to detect leaks of different pipes.
- Nebulization technology of heat conductivity. Smog no scorched smelling
- 5 min intelligent work cycle
- Good helper of decoder



Cleaning machine



AE3101 AE3101-3  
Cleaning machine



AE3102 AE3102-3  
Cleaning machine

Technical parameter:

Model	AE3101	AE3101-3
Power	2.8KW	3KW
Voltage	220V	380V
Frequency	50Hz	50Hz
Motor speed	1430r/min	1430r/min
Max. Working pressure	10.5Mpa	12.5Mpa
Max. Flow	13L/min	14L/min
Machine stops when the gun turned off	YES	YES
Water inlet method	Self-priming	Self-priming
Overload protection	YES	YES
Noise	≤75db	≤75db

Features:

- Brushless motor, durable
- Pure copper split pump head for easy maintenance
- Super power, super pressure
- Automatic exhaust, quick water out
- Self-priming dual purpose, easy to deal with
- Machine stops when the gun turned off ,and save water and electricity
- Overload protection to ensure the safety

⚠ 12 month(3 months for wearing parts)

Technical parameter:

Model	AE3102	AE3102-3
Power	2.8KW	3KW
Voltage	220V	380V
Frequency	50Hz	50Hz
Motor speed	1430r/min	1430r/min
Max. Working pressure	10.5Mpa	12.5Mpa
Max. Flow	13L/min	14L/min
Machine stops when the gun turned off	YES	YES
Water inlet method	Self-priming	Self-priming
Overload protection	YES	YES
Noise	≤75db	≤75db

Features:

- Brushless motor, durable
- Pure copper split pump head for easy maintenance
- Super power, super pressure
- Automatic exhaust, quick water out
- Self-priming dual purpose, easy to deal with
- Machine stops when the gun turned off ,and save water and electricity
- Overload protection to ensure the safety

⚠ 12 month(3 months for wearing parts)



**AE3111 Vacuum Cleaner**



**Technical parameter:**

Rated power	1.6Kw
Rated Voltage	220V
Rated Frequency	50Hz
Vacuum	≥19Kpa
Air Flow	35L/S
Wire Length	5m
Hose Length	2.5m
Hose diameter	φ40
Blow function	YES
Overload protection	YES
Capacity	35L

**Features:**

- Intelligent water stop valve to ensure that the motor does not enter water
- Intelligent pressure relief, to ensure that the plug does not burn the machine
- Strong heat dissipation to ensure the motor run for a long time
- Metal buckle, firm in use without breaking
- Convenient storage hole, accessories can be stored freely
- 360-degree universal wheel, can be towed freely
- 35L large capacity
- One year warranty for the whole machine(6 months for motor)



**AE3121 High Pressure Cantilever**



**Technical parameter:**

Model	Single arm
Material	Aluminium alloy
Water inlet pipe joint	M22*1.5 (outer) φ14 inner hole
Water outlet pipe joint	M22*1.5(Inner) φ14 inner hole
Work pressure	30Mpa
Size before expansion	1215mm
Size after expansion	1700mm
Length of high pressure water pipe	2000mm

**Features:**

- Aluminum alloy material, light and not rusty
- 360-degree concentric rotating car wash, saving time and effort
- Flexible expansion and contraction, free to adjust the length of the water pipe
- Standard with damping pad to reduce noise
- Standard high-pressure water gun storage rack for easy access to high-pressure water pipes and guns



**AE5971 Plastic tool cart+back hanger(with 20pcs hooks)**



Model	LxWxH (MM)	Net Weight
AE5971	830x434x968	10.3KG

**Features:**

- Detachable structure, PP material, easy to install and store, equipped with 4 wheels, flexible to move



Combinable Hose Reel Set



The selection and installation demonstration of 5 hose reel set

5 single hose reel



1 set of end covers (2 sides)



1 crossbeam + 2 hanger frames

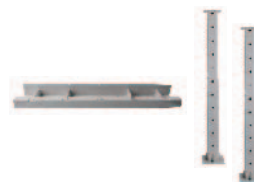

5 hose reel set

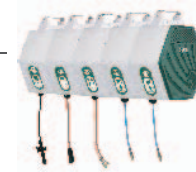

- Easy to installation by one person
- High performance material used on TPU tube from Germany BASF
- High quality steel reel spring with long lifetime

- Special design crossbeam, 6 level height adjustable, easy and stable to assemble
- Corrosion resistant material for valve disk and joints inside
- Optional high-quality blue tooth loud speaker for single hose reel.

⚠ Warranty: 12 months

Air hose reel

Item No.	Air hose specification	Outlet pipe length (M)	Inlet pipe length (M)	Max. working pressure	Other info
AE3001	Inner diameter Φ 6.5mm Outer diameter Φ 10mm	10	0.8	≤1.2Mpa	Operating environment temperature: -10°-60°
AE3002	Inner diameter Φ 6.5mm Outer diameter Φ 10mm	15			
AE3003	Inner diameter Φ 8mm Outer diameter Φ 12mm	10			
AE3004	Inner diameter Φ 6.5mm Inner diameter Φ 10mm	10			Spark proof grade: V0

Water hose reel

Item No.	Water hose specification	Outlet pipe length (M)	Inlet pipe length (M)	Max. working pressure	Operating environment temperature
AE3005	Inner diameter Φ 6.5mm Outer diameter Φ 10mm	8	0.8	≤1.0Mpa	0°-60°
AE3006	Inner diameter Φ 8mm Outer diameter Φ 12mm	8			

Double (air & water) hose reel

Item No.	Hose type	Hose specification	Outlet pipe length (M)	Inlet pipe length (M)	Max. working pressure	Operating environment temperature
AE3007	Air hose	Inner diameter Φ 6.5mm Outer diameter Φ 10mm	7	0.8	≤1Mpa	0°-60°
	Water hose	Inner diameter Φ 7.2mm Outer diameter Φ 10.5mm			≤0.8Mpa	

Electrical socket cable reel

Item No.	Cable specification (MM <sup>2</sup> )	Outlet cable length (M)	Inlet cable length (M)	Max. working pressure	Other info
AE3008	3x1.5	10	0.8	6A 1320W 220VAC	Operating environment temperature: -10°-60° Bluetooth speaker power: 4Ω-3W *2
AE3009		15			
AE3010		10			





Optional Accessories

Item No.	Name	Picture
AE3015	End cover ( 1 set includes two sides)	
AE3016	crossbeam for 2 - hose reel set	
AE3017	crossbeam for 3 - hose reel set	
AE3018	crossbeam for 5 - hose reel set	
AE3019	Hanger frames	 Min length: 750MM; Max length: 1350MM

Selection and Installation

- For single use according to demand, select single hose reel and 1 set end cover(AE3015) to make up one single hose reel.
- For combination
  - option for two combination  
2 single bodies+ 1set cover (AE3015) + 1 crossbeam (AE3016) + 1 Hanger frame (AE3019)
  - option for three combination  
3 bodies+ 1set cover (AE3015) + 1 crossbeam (AE3017) + 1 Hanger frame (AE3019)
  - option for three combination  
5 bodies+ 1set cover (AE3015) + 1 crossbeam (AE3018) + 2 Hanger frame (AE3019)
  - option for multiple combination  
Four combination: double option for two combination  
Six combination: double option for three combination

# G Lifting & Jack Tools

Heavy Duty Service Jack		36
Gearbox Bracket		37
Press		37
Crane		37
Porta Power Kit		38

## 97813 2.5T Heavy Duty Service Jack



No.	Rated load	Net weight	Gross weight	Highest level	Lowest level	Product dimension (mm)
97813	2500 kg	31.5 kg	33.5 kg	460 mm	130 mm	695×345×160

⚠ This product is consumable, not within SATA lifetime warranty

## 97813A 3T Heavy Duty Lowprofile Service Jack

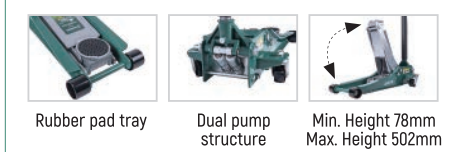

No.	Capacity	N.W.	Max. Height	Min. Height	Product dimension (mm)
97813A	3000KG	35KG	502MM	78MM	687×342×161

- Dual pump design
- Capacity upgrade to 3000KG
- Stroke extend 78-502mm
- Add Rubber pad tray

- Make sure the capacity value reaches the marked value
- Each machine passed 1.5 times load test before leave the factory, ensure adequate safety load factor and product durability(Overload test is carried out in the laboratory, the user should not overload when use)
- When the actual load reaches more than 1.1 times of the rated load, the safety valve automatically opens for protection, and can not rises, ensuring the safety of use
- Double oil hydraulic pump design, according to the amount of the load automatically adjust the lifting speed, fast lifting under light load, when under heavy load to reduce the handle operating force, reduce the user's labor intensity
- Universal joint pressure relief valve structure, more durable
- Tray come with rubber pad, fix the lifting point more better
- Load standards to meet the new American standards ASME PALD-2014

⚠ This product is consumable, not within SATA lifetime warranty

## 97821 1.5T LOW PROFILE ALUMINUM SERVICE JACK

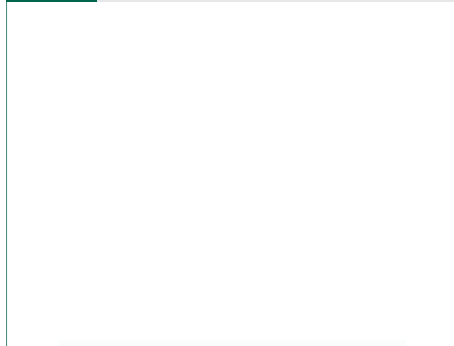

No.	Rated load	Net weight	Gross weight	Highest level	Lowest level	Product dimension (mm)
97821	1500 kg	19.5 kg	21 kg	470 mm	85 mm	715×295×160

- Made of aluminum alloy, light weight, corrosion-resistant
- Rubber mat on the tray will effectively protect raised parts

⚠ This product is consumable, not within SATA lifetime warranty

# REAL TONNAGE

Double pumps, lifting fast

Universal joint steering mechanism, more durable

- Insured under product liability, allowing you rest in mind
- Truly ensure the rated capacity up to the indicated value, with safety guaranteed
- Each unit underwent overload test with 1.5 times of the rated capacity, and must pass the test before leaving the factory, ensuring adequate safety factor (overload test is carried out under laboratory conditions; never operate it under overload)
- When the load reaches 1.1 times of the rated capacity, the safety valve will automatically open and unload, and the load will not raise any more, ensuring safety in use
- Adopt unique two-stage pump, bringing faster lifting speed under no load (to the highest position in three times)

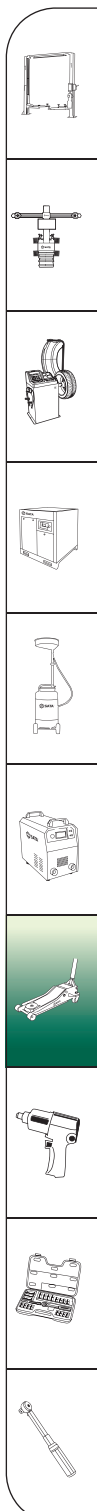

### 0.5T Heavy duty gearbox bracket



Safety valve design, use safety

- High quality special hydraulic oil, minimum tolerable -45°C
- The surface of pump core and piston rod is treated with chrome plating
- Structure classic, specially designed piston rod dustproof ring and pump core dustproof cover
- Fast rise and slow down, adopt speed limit unloading structure (AE5822)
- Special bracket head, 360° adjustable (AE5822)

⚠ Pump and cylinder warranty for 6 months



AE5821



AE5822

Model	Name	Capacity (TON)	Piston Route (MM)		Lowest (MM)	Highest (MM)	Wheel	N.W (KG)	G.W (KG)	Size (CM)
			Class 1	Class 2						
AE5821	0.5T Gearbox bracket	0.5	475	475	812	1760	Iron	51.2	64.0	49×31×77
AE5822	0.5T Heavy duty gearbox bracket	0.5	485	515	927	1933	Rubber cover iron	70.2	79.2	53×28×84

### 20T Press



Safety valve design, use safety

- The surface of pump core and piston rod is treated with chrome plating
- Shockproof pressure gauge, stainless steel case, high precision and long life
- Imported polyurethane oil seal seals, life is longer
- Double speed oil pump design, improve work efficiency (AE5832)
- Equipped with parts box and can be equipped with top end accessories (AE5832-P)

⚠ Pump and cylinder warranty for 6 months



AE5831



AE5832

Model	Name	Capacity (TON)	Highest (MM)	Lowest (MM)	Cylinder route (MM)	Piston route (MM)	N.W (KG)	G.W (KG)	Size (CM)
									1#: 155×19×14 2#: 73×26×17
AE5831	20T Press	20	1010	49	397	185	93	97	
AE5832	20T Heavy duty Press	20	920	40	175	185	112	136	169×71×27

### 2T Crane



Hook height: 1883/2020/2150/2283 mm

- Plug in Design, quickly adjust the position of suspender
- Specially designed base string bag for tools and little parts
- Special hydraulic oil with high quality, applied to -45°C at lowest



Model	Description	Capacity (Kg)	Hook Max Ht (MM)				N.W (KG)	G.W (KG)	Size (CM)
			0.5T Postion	1T Postion	1.5T Postion	0.5T Postion			
AE5841	2T PICKUP CRANE	2000	1883	2020	2150	2283	83.5	86	1#: 153×30.5×16 2#: 82.5×59×9.5

Porta Power Kit



AE5861 4 Ton Porta Power Kit



AE5862 10 Ton Porta Power Kit

- Chrome plated pump core with better wear resistance.
- Seals made of imported material with better performance
- Metal head made of casting steel.

- Scraper seal design, effectively protected from severe environment
- Double speed structure, obviously improving no-load efficiency (AE5862)
- Oil Pump

AE5861 4 Ton Porta Power kit	
Rated capacity	4000 Kg
Min. height of pump	268 mm
Max. height of pump	388 mm
Rise of Piston	120 mm
Net weight	59 Kg
Gross weight	64 Kg
Package Size	60*36*20 cm

AE5862 10 Ton Porta Power Kit	
Rated capacity	10000 Kg
Min. height of pump	322 mm
Max. height of pump	452 mm
Rise of Piston	130 mm
Net weight	64 Kg
Gross weight	73 Kg
Package Size	92*40*19.5 cm

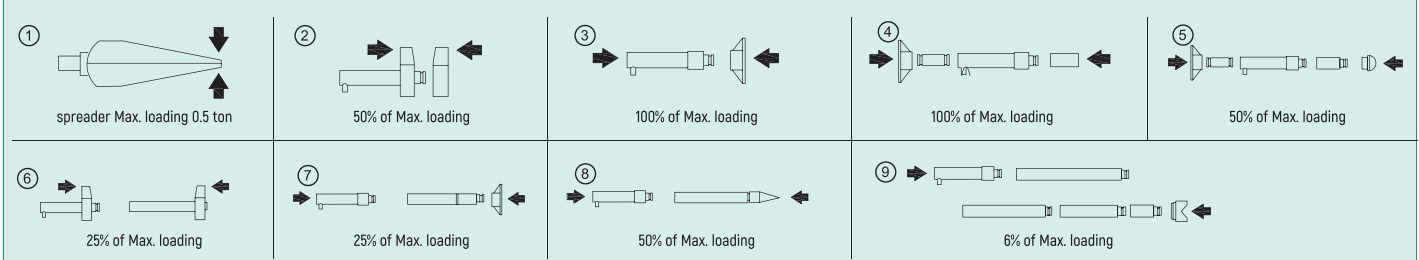



Loading of Head Combination				
Combination	proportion	AE5861	AE5862	
1	Spreader	-	0.5 Ton	0.5 Ton
2	cylinder+Square saddle+hanging foot	50%	2 Ton	5 Ton
3	cylinder+base	100%	4 Ton	10 Ton
4	base+connector+cylinder+round head	100%	4 Ton	10 Ton
5	base+connector+cylinder+1 rod+rubber head	-	0.5 Ton	1 Ton
6	flat head or hanging foot	25%	1 Ton	2.5 Ton
7	cylinder+2 rods+base	25%	1 Ton	2.5 Ton
8	cylinder+1 rods+wedge head	50%	2 Ton	5 Ton
9	cylinder+4 rods+ square head	6%	0.24 Ton	0.6 Ton

Note: The above is only common used, The Max loading should be calculated according to actuality



# H Power Tool

Pneumatic impact wrench  39

Pneumatic grinding machine  40

Lithium battery impact wrench  40



## 01111 1/2" Compact Air Impact Wrench



- Compact air wrench, total length 125mm
- High speed, high impact frequency
- Net weigh 1.5kg

## 01118 1/2" Air Impact Wrench



- Compact design
- Double hammer impact structure
- Maximum reverse torque 750N-M
- Lower exhaust structure

## 01119 1/2" Component Air Impact Wrench



- Double hammer impact structure
- Nylon and glass fiber material shell
- Maximum reverse torque 1050N-M
- Double hammer impact structure

## 01133 1" Air Impact Wrench



- Maximum output torque 4000N-M (Reverse)
- Suitable for disassembly and assembly of tires of heavy trucks and large passenger cars, as well as disassembly and maintenance of heavy vehicle chassis and large mechanical equipment
- The main parts adopt vacuum heat treatment and ultra-low temperature quenching process, which have high hardness, good toughness, good wear resistance and long product life.
- Light weight, effectively reducing labor intensity

Model	Output end Spec.	Idling speed	Working torque	Max.reverse torque	Tighten bolt capacity	Air consumption		Noise	Length	Width	Height	N.W.	Air inlet dimension	Inner diameter of pipe	Standard working pressure	
	in.	RPM	N-m	N-m	DIN 12.9	CFM	L/min						NPT		kg/cm <sup>2</sup>	PSI
01111	1/2"	10000	400	625	M16	4.7	134	110	125	58	177	1.5	1/4"	10	6.35	90
01118	1/2"	8500	600	750	M18	5.4	153	100	161	70	186	2.3	1/4"	10	6.35	90
01119	1/2"	8500	800	1050	M20	4.8	136	89	190	73	185	2.2	1/4"	10	6.35	90
01133	1"	4000	3200	4000	M33	16.0	453	110	623	140	176	16.8	1/2"	12.5	8	116

**01401** Auto 10mm Reversible Air Drill



• Self-locking drill chuck  
• Gear reduction mechanism, strong output

**01501** Auto 6mm Mini Pneumatic Grinder



• Small size, easy to hold  
• Suitable for small space operation

**01503** Auto Pneumatic Low-speed Tire Sander



• Stable low speed  
• Special for tire grinding

Model	01401	01501	01503
Chuck spec.	10mm Chuck	6mm Collet	10mm Quick Coupler
Idling speed RPM	2000	22000	2200
Air consumption	4.0	3.0	3.0
CFM L/min	113	85	113
Noise Db(A)	98	91	98
Length(mm)	202	122	210
Width(mm)	165.8	61.2	70.3
Height(mm)	42	33.5	40.5
N.W.(Kg)	1.21	0.33	1.08
Air inlet dimension(NPT)	1/4"	1/4"	1/4"
Inner diameter of pipe(mm)	8	8	8
Standard working pressure kgf/cm <sup>2</sup>	6.35	6.35	6.35
PSI	90	90	90

**Air Blow Gun**



97231



97232

Model	97231	97232
Inner diameter of air outlet(mm)	φ3.2	φ3.2
Nozzle length(mm)	100	250
Maximum air flow(L/min)	430	430
Length(mm)	245	395
Width(mm)	28	28
Height(mm)	140	140
N.W.(kg)	0.23	0.29

• High-strength gun body  
• Industrial valve body  
• Standard with quick-change rubber nozzle

⚠ This product is consumable, not within SATA lifetime warranty

**01511K** 12pcs Pneumatic shovel and hammer set



**New**

Model	01511K
Shank hole spec.(mm)	φ10
Impact frequency(BPM)	2200
Length(mm)	284
Width(mm)	52
Height(mm)	162
N.W.(kg)	2.2

• Strong impact  
• Variety of accessories  
• Suitable for disassembly of chassis, suspension and brake system components  
• Suitable for dismantling the car body

⚠ Three-month warranty. Accessories and wearing parts are not covered by the warranty

**51073A** 18V LI-ion brushless impact wrench



51505A  
18V Battery charger(2A)



51518A  
2.0Ah Battery



51519A  
4.0Ah Battery









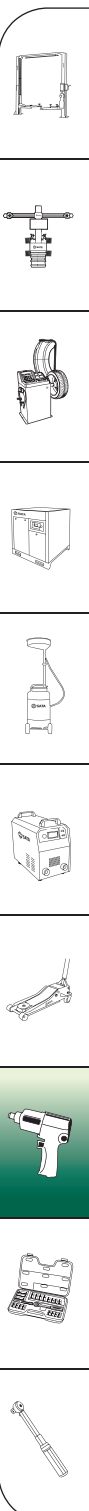

Battery Model	51518A/51519A
Charger Model	51505A
Chuck type	1/2" Square head
Rotating speed 1/Impact frequency 1	0-700/0-1400
Rotating speed 2/Impact frequency 2	0-1600/0-2200
Rotating speed 3/Impact frequency 3	0-2800/0-3600
Max. torque	300NM
Standard bolts	M8-M16
High-strength bolts	M6-M14
Battery Capacity	2.0Ah
Charging time	70min
Weight	14Kg

• Brushless motor, no carbon brush replacement, no reversing sparks, greatly increase the life of the whole machine  
• Ultra-compact body, impact torque can reach 300Nm  
• Three-stage electronic adjustment of speed and impact frequency  
• Fully soft rubber handle provides a comfortable grip  
• Front white LED light design, illuminates the work space



## Auto Maintenance Tool Set & Tool Storage

Mechanic repair Tool Set  41-44

New energy vehicle tool set  45

Trolley Back Hanger  51

09014G 128 pcs 1/4" x 3/8" x 1/2" Dr. Master Tool Set

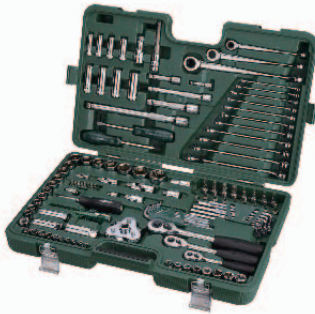

- 10 pcs 1/4" Dr. 6pt. Socket (4, 5, 6, 7, 8, 9, 10, 11, 12, 13 mm)
- 4 pcs 1/4" Dr. 6pt. Deep Socket (8, 9, 10, 12 mm)
- 9 pcs 3/8" Dr. 6pt. Socket (11, 12, 13, 14, 15, 16, 17, 18, 19 mm)
- 4 pcs 3/8" Dr. 6pt. Deep Socket (13, 14, 15, 17 mm)
- 8 pcs 3/8" Dr. Torx Socket (E8, E10, E11, E12, E14, E16, E18, E20)
- 2 pcs 3/8" Dr. Spark Plug Socket (16, 21 mm)
- 7 pcs 1/2" Dr. 6pt. Socket (20, 21, 22, 24, 27, 30, 32 mm)
- 17 pcs 3/8" Dr. Bit Socket  
Bit Socket, Torx (T20, T30, T40, T45, T50, T55, T60)  
Bit Socket, Hexagon (3, 4, 5, 6)  
Bit Socket, Pozidriv (#1, #2)  
Bit Socket, Phillips (#1, #2)  
Bit Socket, Slotted (5.5, 6.5)
- 3 pcs Quick Release Ratchet with Grip (1/4" Dr. 5", 3/8" Dr. 8", 1/2" Dr. 10")
- 3 pcs Universal Joint (1/4", 3/8", 1/2")
- 2 pcs 3/8" Adapter (3/8" F x 1/4" M, 3/8" F x 1/2" M)
- 5 pcs Extension Bar (1/4" Dr. 2", 3/8" Dr. 3", 3/8" Dr. 6", 1/2" Dr. 5", 1/2" Dr. 10")
- 1 pc 1/4" Dr. Socket Driver
- 1 pc Bit Adapter, 1/4" F x 1/4" Hex
- 9 pc 1/4" Dr. Bit Socket Slotted (4, 5, 6.5) Phillips (#1, #3) Hexagon (3, 4, 5, 6)
- 11 pcs Full Polish Combination Wrench (8, 9, 10, 11, 12, 13, 14, 16, 17, 18, 19 mm)
- 2 pc A Series Go Through Screwdriver, Slotted (6x100 mm, #2x100 mm)
- 1 pc T52 Bit Socket Special for Engine Head Screw
- 1 pc Combination Filter Wrench (63-102 mm)
- 1 pc Automotive Circuit Tester 6V/12V/24V
- 1 pc M16 Oil Pan Bits Socket (with hole)
- 1 pc H17 Oil Pan Bits Socket
- 1 pc 3/8" Dt. 12pt. T/W Spark Socket 14 mm
- 10 pcs Long Arm Hex Key Wrench Set
- 9 pcs Long Arm Torx Key Set
- 1 pc 1/2" Dr. Sliding Head (1/2" F x 3/8" M)
- 3 pcs X-beam Combination Ratcheting Wrench 10 mm, 13 mm, 17 mm
- 1 pc Shock Absorber Socket

09941 160PC AUTOMOTIVE MASTER TOOL SET



- 1 pc 11302 1/4" Dr. 6pt. Socket 4MM
- 1 pc 11304 1/4" Dr. 6pt. Socket 5MM
- 1 pc 11306 1/4" Dr. 6pt. Socket 6MM
- 1 pc 11307 1/4" Dr. 6pt. Socket 7MM
- 1 pc 11308 1/4" Dr. 6pt. Socket 8MM
- 1 pc 11309 1/4" Dr. 6pt. Socket 9MM
- 1 pc 11310 1/4" Dr. 6pt. Socket 10MM
- 1 pc 11311 1/4" Dr. 6pt. Socket 11MM
- 1 pc 11312 1/4" Dr. 6pt. Socket 12MM
- 1 pc 11313 1/4" Dr. 6pt. Socket 13MM
- 1 pc 11314 1/4" Dr. 6pt. Socket 14MM
- 1 pc 11405 1/4" Dr. 6pt. Deep Socket 8MM
- 1 pc 11406 1/4" Dr. 6pt. Deep Socket 9MM
- 1 pc 11407 1/4" Dr. 6pt. Deep Socket 10MM
- 1 pc 11408 1/4" Dr. 6pt. Deep Socket 11MM
- 1 pc 11409 1/4" Dr. 6pt. Deep Socket 12MM
- 1 pc 11410 1/4" Dr. 6pt. Deep Socket 13MM
- 1 pc 11701 1/4" Dr. Torx Socket E4
- 1 pc 11703 1/4" Dr. Torx Socket E6
- 1 pc 11705 1/4" Dr. Torx Socket E8
- 1 pc 11707 1/4" Dr. Torx Socket E10
- 1 pc 12301 3/8" Dr. 6pt. Socket 6MM
- 1 pc 12302 3/8" Dr. 6pt. Socket 7MM
- 1 pc 12303 3/8" Dr. 6pt. Socket 8MM
- 1 pc 12304 3/8" Dr. 6pt. Socket 9MM
- 1 pc 12305 3/8" Dr. 6pt. Socket 10MM
- 1 pc 12306 3/8" Dr. 6pt. Socket 11MM
- 1 pc 12307 3/8" Dr. 6pt. Socket 12MM
- 1 pc 12308 3/8" Dr. 6pt. Socket 13MM
- 1 pc 12309 3/8" Dr. 6pt. Socket 14MM
- 1 pc 12310 3/8" Dr. 6pt. Socket 15MM
- 1 pc 12311 3/8" Dr. 6pt. Socket 16MM
- 1 pc 12312 3/8" Dr. 6pt. Socket 17MM
- 1 pc 12313 3/8" Dr. 6pt. Socket 18MM
- 1 pc 12314 3/8" Dr. 6pt. Socket 19MM
- 1 pc 12401 3/8" Dr. 6pt. Deep Socket 8MM
- 1 pc 12403 3/8" Dr. 6pt. Deep Socket 10MM
- 1 pc 12404 3/8" Dr. 6pt. Deep Socket 11MM
- 1 pc 12405 3/8" Dr. 6pt. Deep Socket 12MM
- 1 pc 12406 3/8" Dr. 6pt. Deep Socket 13MM
- 1 pc 12407 3/8" Dr. 6pt. Deep Socket 14MM
- 1 pc 12408 3/8" Dr. 6pt. Deep Socket 15MM
- 1 pc 12410 3/8" Dr. 6pt. Deep Socket 17MM
- 1 pc 12412 3/8" Dr. 6pt. Deep Socket 19MM
- 1 pc 12701 3/8" Dr. Torx Socket E4
- 1 pc 12702 3/8" Dr. Torx Socket E5
- 1 pc 12703 3/8" Dr. Torx Socket E6
- 1 pc 12704 3/8" Dr. Torx Socket E7
- 1 pc 12705 3/8" Dr. Torx Socket E8
- 1 pc 12706 3/8" Dr. Torx Socket E10
- 1 pc 12707 3/8" Dr. Torx Socket E11
- 1 pc 12708 3/8" Dr. Torx Socket E12
- 1 pc 12709 3/8" Dr. Torx Socket E14
- 1 pc 12710 3/8" Dr. Torx Socket E16
- 1 pc 12711 3/8" Dr. Torx Socket E18
- 1 pc 12712 3/8" Dr. Torx Socket E20
- 1 pc 12915 3/8" Dr. Spark Plug Socket 16MM
- 1 pc 12916 3/8" Dr. Spark Plug Socket 21MM
- 1 pc 13601 1/2" Dr12pt. Socket 10MM
- 1 pc 13602 1/2" Dr12pt. Socket 11MM
- 1 pc 13603 1/2" Dr12pt. Socket 12MM
- 1 pc 13604 1/2" Dr12pt. Socket 13MM
- 1 pc 13605 1/2" Dr12pt. Socket 14MM
- 1 pc 13606 1/2" Dr12pt. Socket 15MM
- 1 pc 13607 1/2" Dr12pt. Socket 16MM
- 1 pc 13608 1/2" Dr12pt. Socket 17MM
- 1 pc 13609 1/2" Dr12pt. Socket 18MM
- 1 pc 13610 1/2" Dr12pt. Socket 19MM
- 1 pc 13611 1/2" Dr12pt. Socket 20MM
- 1 pc 13612 1/2" Dr12pt. Socket 21MM
- 1 pc 13613 1/2" Dr12pt. Socket 22MM
- 1 pc 13614 1/2" Dr12pt. Socket 23MM
- 1 pc 13615 1/2" Dr12pt. Socket 24MM
- 1 pc 13616 1/2" Dr12pt. Socket 27MM
- 1 pc 13617 1/2" Dr12pt. Socket 30MM
- 1 pc 13618 1/2" Dr12pt. Socket 32MM
- 1 pc 22103 3/8" Dr. Bit Socket, Torx T20
- 1 pc 22106 3/8" Dr. Bit Socket, Torx T30
- 1 pc 22107 3/8" Dr. Bit Socket, Torx T40
- 1 pc 22601 3/8" Dr. Bit Socket, 50MM Length, Resistorx TT45
- 1 pc 22602 3/8" Dr. Bit Socket, 50MM Length, Resistorx TT50
- 1 pc 22603 3/8" Dr. Bit Socket, 50MM Length, Resistorx TT55
- 1 pc 22604 3/8" Dr. Bit Socket, 50MM Length, Resistorx TT60
- 1 pc 22201 3/8" Dr. Bit Socket, Hexagon 3MM
- 1 pc 22202 3/8" Dr. Bit Socket, Hexagon 4MM
- 1 pc 22203 3/8" Dr. Bit Socket, Hexagon 5MM
- 1 pc 22204 3/8" Dr. Bit Socket, Hexagon 6MM
- 1 pc 22401 3/8" Dr. Bit Socket, Pozidriv #1
- 1 pc 22402 3/8" Dr. Bit Socket, Pozidriv #2
- 1 pc 22301 3/8" Dr. Bit Socket, Phillips #1
- 1 pc 22302 3/8" Dr. Bit Socket, Phillips #2
- 1 pc 22501 3/8" Dr. Bit Socket, Slotted 5.5MM
- 1 pc 22502 3/8" Dr. Bit Socket, Slotted 6.5MM
- 1 pc 11902 1/4" Dr. Quick Release Ratchet with Grip 5"
- 1 pc 12902 3/8" Dr. Quick Release Ratchet with Grip 8"
- 1 pc 13902 1/2" Dr. Quick Release Ratchet with Grip 10"
- 1 pc 11912 Universal Joint, 1/4"Fx1/4" M
- 1 pc 12912 Universal Joint, 3/8"Fx3/8" M
- 1 pc 13912 Universal Joint, 1/2"Fx1/2" M
- 1 pc 12913 Socket Adaptor, 3/8"Fx1/4" M
- 1 pc 12930 3/8" Dr. Sliding Head, 3/8" Mx1/2" F
- 1 pc 11903 1/4" Dr. Extension Bar 2"
- 1 pc 12903 3/8" Dr. Extension Bar 3"
- 1 pc 12904 3/8" Dr. Extension Bar 6"
- 1 pc 13904 1/2" Dr. Extension Bar 5"
- 1 pc 13905 1/2" Dr. Extension Bar 10"
- 1 pc 11911 1/4" Dr. Plastic Handle Driver Bit Adaptor, 1/4"Fx1/4" Hexagon
- 1 pc 50213 1/4" Hex Shank Bit, Slotted 4MM, 25MM Length
- 1 pc 50215 1/4" Hex Shank Bit, Slotted 5MM, 25MM Length
- 1 pc 50218 1/4" Hex Shank Bit, Slotted 6.5MM, 25MM Length
- 1 pc 50222 1/4" Hex Shank Bit, Phillips #1, 25MM Length
- 1 pc 50224 1/4" Hex Shank Bit, Phillips #3, 25MM Length
- 1 pc 50253 1/4" Hex Shank Bit, Hexagon 3MM, 25MM Length
- 1 pc 50254 1/4" Hex Shank Bit, Hexagon 4MM, 25MM Length
- 1 pc 50255 1/4" Hex Shank Bit, Hexagon 5MM, 25MM Length
- 1 pc 50256 1/4" Hex Shank Bit, Hexagon 6MM, 25MM Length
- 1 pc 43201 Full Polish Combination Ratcheting Wrench 8MM
- 1 pc 43202 Full Polish Combination Ratcheting Wrench 9MM
- 1 pc 43203 Full Polish Combination Ratcheting Wrench 10MM
- 1 pc 43204 Full Polish Combination Ratcheting Wrench 11MM
- 1 pc 43205 Full Polish Combination Ratcheting Wrench 12MM
- 1 pc 43206 Full Polish Combination Ratcheting Wrench 13MM
- 1 pc 43207 Full Polish Combination Ratcheting Wrench 14MM
- 1 pc 43208 Full Polish Combination Ratcheting Wrench 15MM
- 1 pc 43209 Full Polish Combination Ratcheting Wrench 16MM
- 1 pc 43210 Full Polish Combination Ratcheting Wrench 17MM
- 1 pc 43211 Full Polish Combination Ratcheting Wrench 18MM
- 1 pc 43212 Full Polish Combination Ratcheting Wrench 19MM
- 1 pc 43213 Full Polish Combination Ratcheting Wrench 21MM
- 1 pc 43214 Full Polish Combination Ratcheting Wrench 22MM
- 1 pc 61613 A Series Go Through Screwdriver, Slotted 6x100MM
- 1 pc 61713 A Series Go Through Screwdriver, Phillips #2x100MM
- 1 pc 97422 Universal 3-jaw Oil Filter Wrench 63-102MM
- 1 pc 62503 Automotive Circuit Tester 6V/12V/24V
- 1 pc 97631 Oil Pan Bits Socket (With Hole) M16
- 1 pc 97635 Oil Pan Bits Socket H17
- 1 pc 12925 3/8" Dr. 12Pt T/W Spark Socket 14MM
- 10 pcs 09128 10Pc Extra Long Arm Hex Key Wrench Set
- 9 pcs 09702 9Pc Long Arm Torx Key Wrench Set
- 1 pc 13900 1/2" Dr. Sliding Head, 1/2"Fx3/8" M
- 1 pc 70512 Slip Joint Pliers 8"
- 1 pc 70101A Long Nose Pliers 6"



09942 60PC AUTOMOTIVE MASTER TOOL SET



- 1 pc 40203 Full Polish Combination Wrench 8MM
- 1 pc 40204 Full Polish Combination Wrench 9MM
- 1 pc 40205 Full Polish Combination Wrench 10MM
- 1 pc 40206 Full Polish Combination Wrench 11MM
- 1 pc 40207 Full Polish Combination Wrench 12MM
- 1 pc 40208 Full Polish Combination Wrench 13MM
- 1 pc 40209 Full Polish Combination Wrench 14MM
- 1 pc 40210 Full Polish Combination Wrench 15MM
- 1 pc 40211 Full Polish Combination Wrench 16MM
- 1 pc 40212 Full Polish Combination Wrench 17MM
- 1 pc 40213 Full Polish Combination Wrench 18MM
- 1 pc 40214 Full Polish Combination Wrench 19MM
- 1 pc 40217 Full Polish Combination Wrench 22MM
- 1 pc 12915 3/8" Dr. Spark Plug Socket 16MM
- 1 pc 12916 3/8" Dr. Spark Plug Socket 21MM
- 1 pc 12302 3/8" Dr. 6pt. Socket 7MM
- 1 pc 12303 3/8" Dr. 6pt. Socket 8MM
- 1 pc 12304 3/8" Dr. 6pt. Socket 9MM
- 1 pc 12305 3/8" Dr. 6pt. Socket 10MM
- 1 pc 12306 3/8" Dr. 6pt. Socket 11MM
- 1 pc 12307 3/8" Dr. 6pt. Socket 12MM
- 1 pc 12308 3/8" Dr. 6pt. Socket 13MM
- 1 pc 12309 3/8" Dr. 6pt. Socket 14MM
- 1 pc 12310 3/8" Dr. 6pt. Socket 15MM
- 1 pc 12311 3/8" Dr. 6pt. Socket 16MM
- 1 pc 12312 3/8" Dr. 6pt. Socket 17MM
- 1 pc 12313 3/8" Dr. 6pt. Socket 18MM
- 1 pc 12314 3/8" Dr. 6pt. Socket 19MM
- 1 pc 12315 3/8" Dr. 6pt. Socket 20MM
- 1 pc 12316 3/8" Dr. 6pt. Socket 21MM
- 1 pc 12317 3/8" Dr. 6pt. Socket 22MM
- 1 pc 12318 3/8" Dr. 6pt. Socket 24MM
- 1 pc 12902 3/8" Dr. Quick Release Ratchet with Grip 8"
- 1 pc 12903 3/8" Dr. Extension Bar 3"
- 1 pc 12904 3/8" Dr. Extension Bar 6"
- 1 pc 12912 Universal Joint, 3/8"Fx3/8" M
- 1 pc 12913 Socket Adaptor, 3/8"Fx1/4" M
- 1 pc 13930 1/2" Dr. Sliding Head, 1/2"Fx3/8" M
- 1 pc 11913 Socket Adaptor, 1/4"Fx3/8" M
- 1 pc 11911 1/4" Dr. Plastic Handle Driver
- 1 pc 11914 Bit Adaptor, 1/4"Fx1/4" Hexagon
- 1 pc 50213 1/4" Hex Shank Bit, Slotted 4MM, 25MM Length
- 1 pc 50215 1/4" Hex Shank Bit, Slotted 5MM, 25MM Length
- 1 pc 50218 1/4" Hex Shank Bit, Slotted 6.5MM, 25MM Length
- 1 pc 50222 1/4" Hex Shank Bit, Phillips #1, 25MM Length
- 1 pc 50224 1/4" Hex Shank Bit, Phillips #3, 25MM Length
- 1 pc 50253 1/4" Hex Shank Bit, Hexagon 3MM, 25MM Length
- 1 pc 50254 1/4" Hex Shank Bit, Hexagon 4MM, 25MM Length
- 1 pc 50255 1/4" Hex Shank Bit, Hexagon 5MM, 25MM Length
- 1 pc 50256 1/4" Hex Shank Bit, Hexagon 6MM, 25MM Length
- 1 pc 50232 1/4" Hex Shank Bit, Torx T10, 25MM Length
- 1 pc 50233 1/4" Hex Shank Bit, Torx T15, 25MM Length
- 1 pc 50234 1/4" Hex Shank Bit, Torx T20, 25MM Length
- 1 pc 50235 1/4" Hex Shank Bit, Torx T25, 25MM Length
- 1 pc 50237 1/4" Hex Shank Bit, Torx T30, 25MM Length
- 1 pc 50238 1/4" Hex Shank Bit, Torx T40, 25MM Length
- 1 pc 70512 Slip Joint Pliers 8"
- 1 pc 70101A Long Nose Pliers 6"
- 1 pc 61613 A Series Go Through Screwdriver, Slotted 6x100MM
- 1 pc 61713 A Series Go Through Screwdriver, Phillips #2x100MM

09943 42PC 1/4" DR. SOCKET SET



- 1 pc 11301 1/4" Dr. 6pt. Socket 3.5MM
- 1 pc 11302 1/4" Dr. 6pt. Socket 4MM
- 1 pc 11303 1/4" Dr. 6pt. Socket 4.5MM
- 1 pc 11304 1/4" Dr. 6pt. Socket 5MM
- 1 pc 11305 1/4" Dr. 6pt. Socket 5.5MM
- 1 pc 11306 1/4" Dr. 6pt. Socket 6MM
- 1 pc 11307 1/4" Dr. 6pt. Socket 7MM
- 1 pc 11308 1/4" Dr. 6pt. Socket 8MM
- 1 pc 11309 1/4" Dr. 6pt. Socket 9MM
- 1 pc 11310 1/4" Dr. 6pt. Socket 10MM
- 1 pc 11311 1/4" Dr. 6pt. Socket 11MM
- 1 pc 11312 1/4" Dr. 6pt. Socket 12MM
- 1 pc 11313 1/4" Dr. 6pt. Socket 13MM
- 1 pc 11314 1/4" Dr. 6pt. Socket 14MM
- 1 pc 11405 1/4" Dr. 6pt. Deep Socket 8MM
- 1 pc 11407 1/4" Dr. 6pt. Deep Socket 10MM
- 1 pc 11408 1/4" Dr. 6pt. Deep Socket 11MM
- 1 pc 11409 1/4" Dr. 6pt. Deep Socket 12MM
- 1 pc 11410 1/4" Dr. 6pt. Deep Socket 13MM
- 1 pc 11902 1/4" Dr. Quick Release Ratchet with Grip 5"
- 1 pc 11903 1/4" Dr. Extension Bar 2"
- 1 pc 11904 1/4" Dr. Extension Bar 4"
- 1 pc 11910 1/4" Dr. Sliding T-handle 4"
- 1 pc 11911 1/4" Dr. Plastic Handle Driver
- 1 pc 11912 Universal Joint, 1/4"Fx1/4" M
- 1 pc 21102 1/4" Dr. Bit Socket, Torx T10
- 1 pc 21103 1/4" Dr. Bit Socket, Torx T15
- 1 pc 21104 1/4" Dr. Bit Socket, Torx T20
- 1 pc 21105 1/4" Dr. Bit Socket, Torx T25
- 1 pc 21106 1/4" Dr. Bit Socket, Torx T30
- 1 pc 21107 1/4" Dr. Bit Socket, Torx T40
- 1 pc 21201 1/4" Dr. Bit Socket, Hexagon 3MM
- 1 pc 21202 1/4" Dr. Bit Socket, Hexagon 4MM
- 1 pc 21203 1/4" Dr. Bit Socket, Hexagon 5MM
- 1 pc 21204 1/4" Dr. Bit Socket, Hexagon 6MM
- 1 pc 21206 1/4" Dr. Bit Socket, Hexagon 7MM
- 1 pc 21205 1/4" Dr. Bit Socket, Hexagon 8MM
- 1 pc 21301 1/4" Dr. Bit Socket, Phillips #1
- 1 pc 21302 1/4" Dr. Bit Socket, Phillips #2
- 1 pc 21501 1/4" Dr. Bit Socket, Slotted 4MM
- 1 pc 21502 1/4" Dr. Bit Socket, Slotted 5.5MM
- 1 pc 21503 1/4" Dr. Bit Socket, Slotted 6.5MM

09944 58PC 3/8" DR. SOCKET SET



- 1 pc 12301 3/8" Dr. 6pt. Socket 6MM
- 1 pc 12302 3/8" Dr. 6pt. Socket 7MM
- 1 pc 12303 3/8" Dr. 6pt. Socket 8MM
- 1 pc 12304 3/8" Dr. 6pt. Socket 9MM
- 1 pc 12305 3/8" Dr. 6pt. Socket 10MM
- 1 pc 12306 3/8" Dr. 6pt. Socket 11MM
- 1 pc 12307 3/8" Dr. 6pt. Socket 12MM
- 1 pc 12308 3/8" Dr. 6pt. Socket 13MM
- 1 pc 12309 3/8" Dr. 6pt. Socket 14MM
- 1 pc 12310 3/8" Dr. 6pt. Socket 15MM
- 1 pc 12311 3/8" Dr. 6pt. Socket 16MM
- 1 pc 12312 3/8" Dr. 6pt. Socket 17MM
- 1 pc 12313 3/8" Dr. 6pt. Socket 18MM
- 1 pc 12314 3/8" Dr. 6pt. Socket 19MM
- 1 pc 12315 3/8" Dr. 6pt. Socket 20MM
- 1 pc 12316 3/8" Dr. 6pt. Socket 21MM
- 1 pc 12317 3/8" Dr. 6pt. Socket 22MM
- 1 pc 12318 3/8" Dr. 6pt. Socket 24MM
- 1 pc 12915 3/8" Dr. Spark Plug Socket 16MM
- 1 pc 12916 3/8" Dr. Spark Plug Socket 21MM
- 1 pc 12925 3/8" Dr. 12pt T/W spark socket 14MM
- 1 pc 12401 3/8" Dr. 6pt. Deep Socket 8MM
- 1 pc 12403 3/8" Dr. 6pt. Deep Socket 10MM
- 1 pc 12404 3/8" Dr. 6pt. Deep Socket 11MM
- 1 pc 12405 3/8" Dr. 6pt. Deep Socket 12MM
- 1 pc 12406 3/8" Dr. 6pt. Deep Socket 13MM
- 1 pc 12407 3/8" Dr. 6pt. Deep Socket 14MM
- 1 pc 12408 3/8" Dr. 6pt. Deep Socket 15MM
- 1 pc 12410 3/8" Dr. 6pt. Deep Socket 17MM
- 1 pc 12412 3/8" Dr. 6pt. Deep Socket 19MM
- 1 pc 22101 3/8" Dr. Bit Socket, Torx T10
- 1 pc 22102 3/8" Dr. Bit Socket, Torx T15
- 1 pc 22103 3/8" Dr. Bit Socket, Torx T20
- 1 pc 22104 3/8" Dr. Bit Socket, Torx T25
- 1 pc 22106 3/8" Dr. Bit Socket, Torx T30
- 1 pc 22107 3/8" Dr. Bit Socket, Torx T40
- 1 pc 22108 3/8" Dr. Bit Socket, Torx T45
- 1 pc 22109 3/8" Dr. Bit Socket, Torx T50
- 1 pc 22110 3/8" Dr. Bit Socket, Torx T55
- 1 pc 22201 3/8" Dr. Bit Socket, Hexagon 3MM
- 1 pc 22202 3/8" Dr. Bit Socket, Hexagon 4MM
- 1 pc 22203 3/8" Dr. Bit Socket, Hexagon 5MM
- 1 pc 22204 3/8" Dr. Bit Socket, Hexagon 6MM
- 1 pc 22205 3/8" Dr. Bit Socket, Hexagon 7MM
- 1 pc 22206 3/8" Dr. Bit Socket, Hexagon 8MM
- 1 pc 22207 3/8" Dr. Bit Socket, Hexagon 10MM
- 1 pc 22301 3/8" Dr. Bit Socket, Phillips #1
- 1 pc 22302 3/8" Dr. Bit Socket, Phillips #2
- 1 pc 22303 3/8" Dr. Bit Socket, Phillips #3
- 1 pc 22501 3/8" Dr. Bit Socket, Slotted 5.5MM
- 1 pc 22502 3/8" Dr. Bit Socket, Slotted 6.5MM
- 1 pc 22503 3/8" Dr. Bit Socket, Slotted 8MM
- 1 pc 12903 3/8" Dr. Extension Bar 3"
- 1 pc 12904 3/8" Dr. Extension Bar 6"
- 1 pc 12905 3/8" Dr. Extension Bar 10"
- 1 pc 12902 3/8" Dr. Quick Release Ratchet with Grip 8"
- 1 pc 12912 Universal Joint, 3/8"Fx3/8" M
- 1 pc 12914 Socket Adaptor, 3/8"Fx1/2" M



**09945 34PC 1/2" DR.SOCKET SET**



- 1 pc 13601 1/2" Dr.12pt. Socket 10MM
- 1 pc 13602 1/2" Dr.12pt. Socket 11MM
- 1 pc 13603 1/2" Dr.12pt. Socket 12MM
- 1 pc 13604 1/2" Dr.12pt. Socket 13MM
- 1 pc 13605 1/2" Dr.12pt. Socket 14MM
- 1 pc 13606 1/2" Dr.12pt. Socket 15MM
- 1 pc 13607 1/2" Dr.12pt. Socket 16MM
- 1 pc 13608 1/2" Dr.12pt. Socket 17MM
- 1 pc 13609 1/2" Dr.12pt. Socket 18MM
- 1 pc 13610 1/2" Dr.12pt. Socket 19MM
- 1 pc 13611 1/2" Dr.12pt. Socket 20MM
- 1 pc 13612 1/2" Dr.12pt. Socket 21MM
- 1 pc 13613 1/2" Dr.12pt. Socket 22MM
- 1 pc 13614 1/2" Dr.12pt. Socket 23MM
- 1 pc 13615 1/2" Dr.12pt. Socket 24MM
- 1 pc 13616 1/2" Dr.12pt. Socket 27MM
- 1 pc 13617 1/2" Dr.12pt. Socket 30MM
- 1 pc 13618 1/2" Dr.12pt. Socket 32MM
- 1 pc 13912 Universal Joint, 1/2"Fx1/2"M
- 1 pc 13904 1/2" Dr. Extension Bar 5"
- 1 pc 13905 1/2" Dr. Extension Bar 10"
- 1 pc 13902 1/2" Dr. Quick Release Ratchet with Grip 10"
- 1 pc 13930 1/2" Dr. Sliding Head, 1/2"Fx3/8"M
- 1 pc 13812 1/2" Dr. 12Pt.Deep socket 12MM
- 1 pc 13813 1/2" Dr. 12Pt Deep socket 13MM
- 1 pc 13814 1/2" Dr. 12Pt Deep socket 14MM
- 1 pc 13817 1/2" Dr. 12Pt Deep socket 17MM
- 1 pc 13819 1/2" Dr. 12Pt Deep socket 19MM
- 1 pc 13703 1/2" Dr. Torx Socket E14
- 1 pc 13704 1/2" Dr. Torx Socket E16
- 1 pc 13705 1/2" Dr. Torx Socket E18
- 1 pc 13706 1/2" Dr. Torx Socket E20
- 1 pc 13707 1/2" Dr. Torx Socket E22
- 1 pc 13708 1/2" Dr. Torx Socket E24

**09946 188PC TOOL SET WITH 6 DRAWER TROLLEY 95126**



- 1 pc 11302 1/4" Dr. 6pt. Socket 4MM
- 1 pc 11304 1/4" Dr. 6pt. Socket 5MM
- 1 pc 11306 1/4" Dr. 6pt. Socket 6MM
- 1 pc 11307 1/4" Dr. 6pt. Socket 7MM
- 1 pc 11308 1/4" Dr. 6pt. Socket 8MM
- 1 pc 11309 1/4" Dr. 6pt. Socket 9MM
- 1 pc 11310 1/4" Dr. 6pt. Socket 10MM
- 1 pc 11311 1/4" Dr. 6pt. Socket 11MM
- 1 pc 11312 1/4" Dr. 6pt. Socket 12MM
- 1 pc 11313 1/4" Dr. 6pt. Socket 13MM
- 1 pc 11405 1/4" Dr. 6pt. Deep Socket 8MM
- 1 pc 11406 1/4" Dr. 6pt. Deep Socket 9MM
- 1 pc 11407 1/4" Dr. 6pt. Deep Socket 10MM
- 1 pc 11409 1/4" Dr. 6pt. Deep Socket 12MM
- 1 pc 12306 3/8" Dr. 6pt. Socket 11MM
- 1 pc 12307 3/8" Dr. 6pt. Socket 12MM
- 1 pc 12308 3/8" Dr. 6pt. Socket 13MM
- 1 pc 12309 3/8" Dr. 6pt. Socket 14MM
- 1 pc 12310 3/8" Dr. 6pt. Socket 15MM
- 1 pc 12311 3/8" Dr. 6pt. Socket 16MM
- 1 pc 12312 3/8" Dr. 6pt. Socket 17MM
- 1 pc 12313 3/8" Dr. 6pt. Socket 18MM
- 1 pc 12314 3/8" Dr. 6pt. Socket 19MM
- 1 pc 12406 3/8" Dr. 6pt. Deep Socket 13MM
- 1 pc 12407 3/8" Dr. 6pt. Deep Socket 14MM
- 1 pc 12408 3/8" Dr. 6pt. Deep Socket 15MM
- 1 pc 12410 3/8" Dr. 6pt. Deep Socket 17MM
- 1 pc 12705 3/8" Dr. Torx Socket E8
- 1 pc 12706 3/8" Dr. Torx Socket E10
- 1 pc 12707 3/8" Dr. Torx Socket E11
- 1 pc 12708 3/8" Dr. Torx Socket E12
- 1 pc 12709 3/8" Dr. Torx Socket E14
- 1 pc 12710 3/8" Dr. Torx Socket E16
- 1 pc 12711 3/8" Dr. Torx Socket E18
- 1 pc 12712 3/8" Dr. Torx Socket E20
- 1 pc 12915 3/8" Dr. Spark Plug Socket 16MM
- 1 pc 12916 3/8" Dr. Spark Plug Socket 21MM
- 1 pc 13311 1/2" Dr. 6pt. Socket 20MM
- 1 pc 13312 1/2" Dr. 6pt. Socket 21MM
- 1 pc 13313 1/2" Dr. 6pt. Socket 22MM
- 1 pc 13315 1/2" Dr. 6pt. Socket 24MM
- 1 pc 13316 1/2" Dr. 6pt. Socket 27MM
- 1 pc 13317 1/2" Dr. 6pt. Socket 30MM
- 1 pc 13318 1/2" Dr. 6pt. Socket 32MM
- 1 pc 34410T 1/2" Dr. 6pt. Thin Wall Impact deep socket 17MM
- 1 pc 3442T 1/2" Dr. 6pt. Thin Wall Impact deep socket 19MM
- 1 pc 22103 3/8" Dr. Bit Socket, Torx T20
- 1 pc 22106 3/8" Dr. Bit Socket, Torx T30
- 1 pc 22107 3/8" Dr. Bit Socket, Torx T40
- 1 pc 22601 3/8" Dr. Bit Socket, 50MM Length, Resistorx TT45
- 1 pc 22602 3/8" Dr. Bit Socket, 50MM Length, Resistorx TT50
- 1 pc 22603 3/8" Dr. Bit Socket, 50MM Length, Resistorx TT55
- 1 pc 22604 3/8" Dr. Bit Socket, 50MM Length, Resistorx TT60
- 1 pc 22201 3/8" Dr. Bit Socket, Hexagon 3MM
- 1 pc 22202 3/8" Dr. Bit Socket, Hexagon 4MM
- 1 pc 22203 3/8" Dr. Bit Socket, Hexagon 5MM
- 1 pc 22204 3/8" Dr. Bit Socket, Hexagon 6MM
- 1 pc 22401 3/8" Dr. Bit Socket, Pozidriv #1
- 1 pc 22402 3/8" Dr. Bit Socket, Pozidriv #2
- 1 pc 22301 3/8" Dr. Bit Socket, Phillips #1
- 1 pc 22302 3/8" Dr. Bit Socket, Phillips #2
- 1 pc 22501 3/8" Dr. Bit Socket, Slotted 5.5MM
- 1 pc 22502 3/8" Dr. Bit Socket, Slotted 6.5MM
- 1 pc 11902 1/4" Dr. Quick Release Ratchet with Grip 5"
- 1 pc 12902 3/8" Dr. Quick Release Ratchet with Grip 8"
- 1 pc 13902 1/2" Dr. Quick Release Ratchet with Grip 10"
- 1 pc 11912 Universal Joint, 1/4"Fx1/4M
- 1 pc 12912 Universal Joint, 3/8"Fx3/8M
- 1 pc 13912 Universal Joint, 1/2"Fx1/2M
- 1 pc 12913 Socket Adaptor, 3/8"Fx1/4M
- 1 pc 12930 3/8" Dr. Sliding Head, 3/8"Fx1/4M
- 1 pc 11903 1/4" Dr. Extension Bar 2"
- 1 pc 12903 3/8" Dr. Extension Bar 3"
- 1 pc 12904 3/8" Dr. Extension Bar 6"
- 1 pc 13904 1/2" Dr. Extension Bar 5"
- 1 pc 13905 1/2" Dr. Extension Bar 10"
- 1 pc 11911 1/4" Dr. Plastic Handle Driver
- 1 pc 11914 Bit Adaptor, 1/4"Fx1/4"Hexagon
- 1 pc 50213 1/4" Hex Shank Bit, Slotted 4MM, 25MM Length
- 1 pc 50215 1/4" Hex Shank Bit, Slotted 5MM, 25MM Length
- 1 pc 50218 1/4" Hex Shank Bit, Slotted 6.5MM, 25MM Length
- 1 pc 50222 1/4" Hex Shank Bit, Phillips #1, 25MM Length
- 1 pc 50224 1/4" Hex Shank Bit, Phillips #3, 25MM Length
- 1 pc 50253 1/4" Hex Shank Bit, Hexagon 3MM, 25MM Length
- 1 pc 50254 1/4" Hex Shank Bit, Hexagon 4MM, 25MM Length
- 1 pc 50255 1/4" Hex Shank Bit, Hexagon 5MM, 25MM Length
- 1 pc 50256 1/4" Hex Shank Bit, Hexagon 6MM, 25MM Length
- 1 pc 40203 Full Polish Combination Wrench 8MM
- 1 pc 40204 Full Polish Combination Wrench 9MM
- 1 pc 40205 Full Polish Combination Wrench 10MM
- 1 pc 40206 Full Polish Combination Wrench 11MM
- 1 pc 40207 Full Polish Combination Wrench 12MM
- 1 pc 40208 Full Polish Combination Wrench 13MM
- 1 pc 40209 Full Polish Combination Wrench 14MM
- 1 pc 40211 Full Polish Combination Wrench 16MM
- 1 pc 40212 Full Polish Combination Wrench 17MM
- 1 pc 40213 Full Polish Combination Wrench 18MM
- 1 pc 40214 Full Polish Combination Wrench 19MM
- 1 pc 61614 A Series Go Through Screwdriver, Slotted 6x150MM
- 1 pc 61714 A Series Go Through Screwdriver, Phillips #2x150MM
- 1 pc 97619 Bit Socket for Engine Cover Screws
- 1 pc 97422 Universal 3-jaw Oil Filter Wrench 63-102MM
- 1 pc 62503 Automotive Circuit Tester 6V/12V/24V
- 1 pc 97631 Oil Pan Bits Socket (With Hole) M16
- 1 pc 97635 Oil Pan Bits Socket H7
- 1 pc 12925 3/8" Dr. 12Pt T/W Spark Socket 14MM
- 10 pcs 09110 10Pc Extra Long Arm Hex Key Wrench Set
- 9 pcs 09702 9Pc Long Arm Torx Key Wrench Set
- 1 pc 13930 1/2" Dr. Sliding Head, 1/2"Fx3/8"M
- 1 pc 97104 Shock Absorber Removal Socket
- 1 pc 70101A Long Nose Pliers 6"
- 1 pc 70202A Diagonal Pliers 6"
- 1 pc 70303A Combination Pliers 8"
- 1 pc 72001 External Snap Ring Pliers 7, Straight Tips
- 1 pc 72002 External Snap Ring Pliers 7, Curved Tips
- 1 pc 72004 Internal Snap Ring Pliers 7, Straight Tips
- 1 pc 72005 Internal Snap Ring Pliers 7, Curved Tips
- 1 pc 70512 Slip Joint Pliers 8"
- 1 pc 71103 Locking Pliers 10", Curved Jaw
- 1 pc 47203 Adjustable Wrench 8"
- 1 pc 47205 Adjustable Wrench 12"
- 1 pc 61103 A Series Screwdriver, Torx T20x100MM
- 1 pc 61104 A Series Screwdriver, Torx T25x100MM
- 1 pc 61106 A Series Screwdriver, Torx T30x100MM
- 1 pc 62202 A Series Screwdriver, Slotted 3.2x75MM
- 1 pc 62208 A Series Screwdriver, Slotted 5x100MM
- 1 pc 62213 A Series Screwdriver, Slotted 6x150MM
- 1 pc 62302 A Series Screwdriver, Phillips #0x75MM
- 1 pc 62308 A Series Screwdriver, Phillips #1x100MM
- 1 pc 62313 A Series Screwdriver, Phillips #2x150MM
- 1 pc 93422A Plastic Snap-off Knife, 8-point, 18x100MM
- 1 pc 64102 Flexible Magnetic Pickup Tool, 400MMx2KG
- 1 pc 97427 Oil Filter Wrench 55-75MM
- 1 pc 97428 Oil Filter Wrench 75-95MM
- 1 pc 95210 Wood Handle Putty Scraper
- 1 pc 91200 Wire Stripper with Cutter 6"
- 14 pcs 09401 14pc Feeler Gauges Set, 0.05-1.00MM
- 1 pc 48200 Full Polish Flare Nut Wrench 8x10MM
- 1 pc 48201 Full Polish Flare Nut Wrench 9x11MM
- 1 pc 48204 Full Polish Flare Nut Wrench 10x12MM
- 1 pc 48202 Full Polish Flare Nut Wrench 13x14MM
- 1 pc 48203 Full Polish Flare Nut Wrench 16x17MM
- 5 pcs 09161 5Pc Punch set
- 1 pc 92303 Fiberglass Handle Ball Pein Hammer, 1.5 LBS.
- 1 pc 01119 1/2" Air Impact Wrench (Auto Maintenance)
- 1 pc 02515 Pneumatic Low Speed Tyre Sander
- 5 pcs 9704 5pc Extractor Set, Fine Thread
- 1 pc 93106 Multi-purpose Scissor with Two tone handle
- 1 pc 03005 Mini Multimeter
- 1 pc 90756 Double Flash Working Light With Lion Battery ( Pen Style)

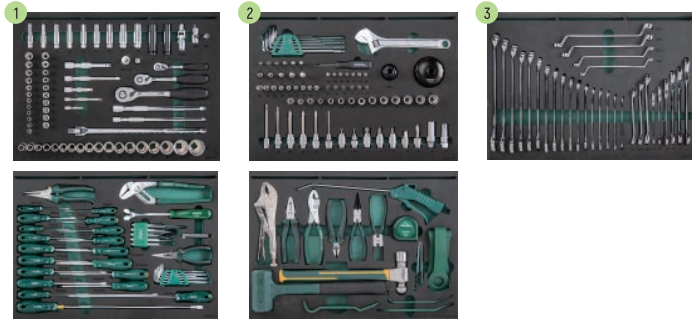

- 1 pc 11302 1/4" Dr. 6pt. Socket 4MM
- 1 pc 11304 1/4" Dr. 6pt. Socket 5MM
- 1 pc 11305 1/4" Dr. 6pt. Socket 5.5MM
- 1 pc 11306 1/4" Dr. 6pt. Socket 6MM
- 1 pc 11307 1/4" Dr. 6pt. Socket 7MM
- 1 pc 11308 1/4" Dr. 6pt. Socket 8MM
- 1 pc 11309 1/4" Dr. 6pt. Socket 9MM
- 1 pc 11310 1/4" Dr. 6pt. Socket 10MM
- 1 pc 11311 1/4" Dr. 6pt. Socket 11MM
- 1 pc 11312 1/4" Dr. 6pt. Socket 12MM
- 1 pc 11313 1/4" Dr. 6pt. Socket 13MM
- 1 pc 11314 1/4" Dr. 6pt. Socket 14MM
- 1 pc 21201 1/4" Dr. Bit Socket, Hexagon 3MM
- 1 pc 21202 1/4" Dr. Bit Socket, Hexagon 4MM
- 1 pc 21203 1/4" Dr. Bit Socket, Hexagon 5MM
- 1 pc 21204 1/4" Dr. Bit Socket, Hexagon 6MM
- 1 pc 21206 1/4" Dr. Bit Socket, Hexagon 7MM
- 1 pc 21205 1/4" Dr. Bit Socket, Hexagon 8MM
- 1 pc 21101 1/4" Dr. Bit Socket, Torx T8
- 1 pc 21102 1/4" Dr. Bit Socket, Torx T10
- 1 pc 21103 1/4" Dr. Bit Socket, Torx T15
- 1 pc 21104 1/4" Dr. Bit Socket, Torx T20
- 1 pc 21105 1/4" Dr. Bit Socket, Torx T25
- 1 pc 21106 1/4" Dr. Bit Socket, Torx T30
- 1 pc 21107 1/4" Dr. Bit Socket, Torx T40
- 1 pc 21301 1/4" Dr. Bit Socket, Phillips #1
- 1 pc 21302 1/4" Dr. Bit Socket, Phillips #2
- 1 pc 21303 1/4" Dr. Bit Socket, Phillips #3
- 1 pc 21501 1/4" Dr. Bit Socket, Slotted 4MM
- 1 pc 21502 1/4" Dr. Bit Socket, Slotted 5.5MM
- 1 pc 21503 1/4" Dr. Bit Socket, Slotted 6.5MM
- 1 pc 1911 1/4" Dr. Plastic Handle Driver
- 1 pc 1912 Universal Joint, 1/4"Fx1/4"
- 1 pc 1903 1/4" Dr. Extension Bar 2"
- 1 pc 1904 1/4" Dr. Extension Bar 4"
- 1 pc 1902 1/4" Dr. Quick Release Ratchet with Grip 5"
- 1 pc 12301 3/8" Dr. 6pt. Socket 6MM
- 1 pc 12302 3/8" Dr. 6pt. Socket 7MM
- 1 pc 12303 3/8" Dr. 6pt. Socket 8MM
- 1 pc 12304 3/8" Dr. 6pt. Socket 9MM
- 1 pc 12305 3/8" Dr. 6pt. Socket 10MM
- 1 pc 12306 3/8" Dr. 6pt. Socket 11MM
- 1 pc 12307 3/8" Dr. 6pt. Socket 12MM
- 1 pc 12308 3/8" Dr. 6pt. Socket 13MM
- 1 pc 12309 3/8" Dr. 6pt. Socket 14MM
- 1 pc 12310 3/8" Dr. 6pt. Socket 15MM
- 1 pc 12311 3/8" Dr. 6pt. Socket 16MM
- 1 pc 12312 3/8" Dr. 6pt. Socket 17MM
- 1 pc 12313 3/8" Dr. 6pt. Socket 18MM
- 1 pc 12314 3/8" Dr. 6pt. Socket 19MM
- 1 pc 22203 3/8" Dr. Bit Socket, Hexagon 5MM
- 1 pc 22204 3/8" Dr. Bit Socket, Hexagon 6MM
- 1 pc 22205 3/8" Dr. Bit Socket, Hexagon 7MM
- 1 pc 22206 3/8" Dr. Bit Socket, Hexagon 8MM
- 1 pc 22207 3/8" Dr. Bit Socket, Hexagon 10MM
- 1 pc 22102 3/8" Dr. Bit Socket, Torx T15
- 1 pc 22103 3/8" Dr. Bit Socket, Torx T20
- 1 pc 22104 3/8" Dr. Bit Socket, Torx T25
- 1 pc 22105 3/8" Dr. Bit Socket, Torx T27
- 1 pc 22106 3/8" Dr. Bit Socket, Torx T30
- 1 pc 22107 3/8" Dr. Bit Socket, Torx T40
- 1 pc 22108 3/8" Dr. Bit Socket, Torx T45
- 1 pc 22109 3/8" Dr. Bit Socket, Torx T50
- 1 pc 22110 3/8" Dr. Bit Socket, Torx T55
- 1 pc 12915 3/8" Dr. Spark Plug Socket 16MM
- 1 pc 12916 3/8" Dr. Spark Plug Socket 21MM
- 1 pc 22219 3/8" Dr. Bit Socket, 120MM length, 6pt. 9MM
- 1 pc 12902 3/8" Dr. Quick Release Ratchet with Grip 8"
- 1 pc 12903 3/8" Dr. Extension Bar 3"
- 1 pc 12904 3/8" Dr. Extension Bar 6"
- 1 pc 12905 3/8" Dr. Extension Bar 10"
- 1 pc 12914 Socket Adaptor, 3/8"Fx1/2"
- 1 pc 12930 3/8" Dr. Sliding Head, 3/8"MM/2"
- 1 pc 12401 3/8" Dr. 6pt. Deep Socket 8MM
- 1 pc 12403 3/8" Dr. 6pt. Deep Socket 10MM
- 1 pc 12404 3/8" Dr. 6pt. Deep Socket 11MM
- 1 pc 12405 3/8" Dr. 6pt. Deep Socket 12MM
- 1 pc 12406 3/8" Dr. 6pt. Deep Socket 13MM
- 1 pc 12407 3/8" Dr. 6pt. Deep Socket 14MM
- 1 pc 12408 3/8" Dr. 6pt. Deep Socket 15MM
- 1 pc 12410 3/8" Dr. 6pt. Deep Socket 17MM
- 1 pc 1242 3/8" Dr. 6pt. Deep Socket 19MM
- 1 pc 12701 3/8" Dr. Torx Socket E4
- 1 pc 12702 3/8" Dr. Torx Socket E5
- 1 pc 12703 3/8" Dr. Torx Socket E6
- 1 pc 12704 3/8" Dr. Torx Socket E7
- 1 pc 12705 3/8" Dr. Torx Socket E8
- 1 pc 12706 3/8" Dr. Torx Socket E10
- 1 pc 12707 3/8" Dr. Torx Socket E11
- 1 pc 12708 3/8" Dr. Torx Socket E12
- 1 pc 12709 3/8" Dr. Torx Socket E14
- 1 pc 12710 3/8" Dr. Torx Socket E16
- 1 pc 13601 1/2" Dr.12pt. Socket 10MM
- 1 pc 13602 1/2" Dr.12pt. Socket 11MM
- 1 pc 13603 1/2" Dr.12pt. Socket 12MM
- 1 pc 13604 1/2" Dr.12pt. Socket 13MM
- 1 pc 13605 1/2" Dr.12pt. Socket 14MM
- 1 pc 13606 1/2" Dr.12pt. Socket 15MM
- 1 pc 13607 1/2" Dr.12pt. Socket 16MM
- 1 pc 13608 1/2" Dr.12pt. Socket 17MM
- 1 pc 13609 1/2" Dr.12pt. Socket 18MM
- 1 pc 13610 1/2" Dr.12pt. Socket 19MM
- 1 pc 13611 1/2" Dr.12pt. Socket 20MM
- 1 pc 13612 1/2" Dr.12pt. Socket 21MM
- 1 pc 13613 1/2" Dr.12pt. Socket 22MM
- 1 pc 13614 1/2" Dr.12pt. Socket 23MM
- 1 pc 13615 1/2" Dr.12pt. Socket 24MM
- 1 pc 13616 1/2" Dr.12pt. Socket 27MM
- 1 pc 13617 1/2" Dr.12pt. Socket 30MM
- 1 pc 13618 1/2" Dr.12pt. Socket 32MM
- 1 pc 24804 1/2" Dr. Bit Socket, 50MM Length, 12pt. M10
- 1 pc 24805 1/2" Dr. Bit Socket, 50MM Length, 12pt. M12
- 1 pc 25803 1/2" Dr. Bit Socket, 100MM Length, 12pt. M8
- 1 pc 25804 1/2" Dr. Bit Socket, 100MM Length, 12pt. M10
- 1 pc 25805 1/2" Dr. Bit Socket, 100MM Length, 12pt. M12
- 1 pc 25806 1/2" Dr. Bit Socket, 100MM Length, 12pt. M14
- 1 pc 24207 1/2" Dr. Bit Socket, 50MM Length, Hexagon 12MM
- 1 pc 24208 1/2" Dr. Bit Socket, 50MM Length, Hexagon 14MM
- 1 pc 24211 1/2" Dr. Bit Socket, 50MM Length, Hexagon 19MM
- 1 pc 97631 Oil Pan Bits Socket (With Hole) M16
- 1 pc 97635 Oil Pan Bits Socket H17
- 1 pc 13912 Universal Joint, 1/2"Fx1/2"
- 1 pc 13904 1/2" Dr. Extension Bar 5"
- 1 pc 13905 1/2" Dr. Extension Bar 10"
- 1 pc 13902 1/2" Dr. Quick Release Ratchet with Grip 10"
- 1 pc 13911 1/2" Dr. Breaker Bar 15"
- 1 pc 34410T 1/2" Dr. 6pt. Thin Wall Impact deep socket 17MM
- 1 pc 3442T 1/2" Dr. 6pt. Thin Wall Impact deep socket 19MM
- 1 pc 40203 Full Polish Combination Wrench 8MM
- 1 pc 40204 Full Polish Combination Wrench 9MM
- 1 pc 40205 Full Polish Combination Wrench 10MM
- 1 pc 40206 Full Polish Combination Wrench 11MM
- 1 pc 40207 Full Polish Combination Wrench 12MM
- 1 pc 40208 Full Polish Combination Wrench 13MM
- 1 pc 40209 Full Polish Combination Wrench 14MM
- 1 pc 40210 Full Polish Combination Wrench 15MM
- 1 pc 40211 Full Polish Combination Wrench 16MM
- 1 pc 40212 Full Polish Combination Wrench 17MM
- 1 pc 40213 Full Polish Combination Wrench 18MM
- 1 pc 40214 Full Polish Combination Wrench 19MM
- 1 pc 40215 Full Polish Combination Wrench 20MM
- 1 pc 40216 Full Polish Combination Wrench 21MM
- 1 pc 40217 Full Polish Combination Wrench 22MM
- 1 pc 40218 Full Polish Combination Wrench 23MM
- 1 pc 40219 Full Polish Combination Wrench 24MM
- 1 pc 46421 Full Polish Flexible Ratcheting Wrench 8MM
- 1 pc 46401 Full Polish Flexible Ratcheting Wrench 10MM
- 1 pc 46404 Full Polish Flexible Ratcheting Wrench 13MM
- 1 pc 46406 Full Polish Flexible Ratcheting Wrench 15MM
- 1 pc 46407 Full Polish Flexible Ratcheting Wrench 16MM
- 1 pc 46409 Full Polish Flexible Ratcheting Wrench 18MM
- 1 pc 48201 Full Polish Flare Nut Wrench 9x11MM
- 1 pc 48202 Full Polish Flare Nut Wrench 13x14MM
- 1 pc 48203 Full Polish Flare Nut Wrench 16x17MM
- 1 pc 42303 Full Polish Deep Box End Wrench 10x11MM
- 1 pc 42304 Full Polish Deep Box End Wrench 12x13MM
- 1 pc 42306 Full Polish Deep Box End Wrench 16x17MM
- 1 pc 42307 Full Polish Deep Box End Wrench 18x19MM
- 1 pc 97619 Bit Socket for Engine Cover Screws
- 1 pc 97403 End Cap Oil Filter Wrench 74MM, 15-flute
- 1 pc 97408 End Cap Oil Filter Wrench 36MM, 6-flute
- 1 pc 47204 Adjustable Wrench 10"
- 1 pc 61108 A Series Screwdriver, Torx T8x75MM
- 1 pc 61101 A Series Screwdriver, Torx T10x100MM
- 1 pc 61102 A Series Screwdriver, Torx T15x100MM
- 1 pc 61103 A Series Screwdriver, Torx T20x100MM
- 1 pc 61104 A Series Screwdriver, Torx T25x100MM
- 1 pc 61105 A Series Screwdriver, Torx T27x100MM
- 1 pc 61106 A Series Screwdriver, Torx T30x100MM
- 1 pc 61107 A Series Screwdriver, Torx T40x100MM
- 1 pc 62202 A Series Screwdriver, Slotted 3.2x75MM
- 1 pc 62207 A Series Screwdriver, Slotted 5x75MM
- 1 pc 62213 A Series Screwdriver, Slotted 6x150MM
- 1 pc 62302 A Series Screwdriver, Phillips #0x75MM
- 1 pc 62307 A Series Screwdriver, Phillips #1x75MM
- 1 pc 62313 A Series Screwdriver, Phillips #2x150MM
- 1 pc 62219 A Series Screwdriver, Slotted 5x300MM
- 1 pc 62320 A Series Screwdriver, Phillips #2x300MM
- 1 pc 61614 A Series Go Through Screwdriver, Slotted 6x150MM
- 1 pc 61714 A Series Go Through Screwdriver, Phillips #2x150MM
- 10 pcs 09128 10Pc Extra Long Arm Hex Key Wrench Set
- 9 pcs 09702 9Pc Long Arm Torx Key Wrench Set
- 1 pc 93106 Multi-purpose Scissor with Two tone handle
- 5 pcs 09161 5Pc Punch set
- 74 pcs 09401 14pc Feeler Gauges Set, 0.05-1.00MM
- 1 pc 64011 Flexible Magnetic Pickup Tool, 400MMx1KG
- 1 pc 97109 Pry Bars Driver
- 1 pc 97222 Air Blow Gun 250MM
- 1 pc 70302A Combination Pliers 7"
- 1 pc 70202A Diagonal Pliers 6"
- 1 pc 70101A Long Nose Pliers 6"
- 1 pc 70512 Slip Joint Pliers 8"
- 1 pc 70412 Groove Joint Pliers 10"
- 1 pc 71103 Locking Pliers 10", Curved Jaw
- 1 pc 72012 German Style Internal Snap Ring Pliers 7", Straight Tips
- 1 pc 72032 German Style External Snap Ring Pliers 7", Straight Tips
- 1 pc 91314 ABS Case Tape Measure 5Mx19MM
- 1 pc 92303 Fiberglass Handle Ball Pein Hammer, 15 LBS.
- 1 pc 92923 Dead Blow Soft Rubber Hammer 55MM
- 1 pc 93426 Plastic Snap-off Knife, 13-point, 9x80MM
- 5 pcs 97108 5Pc Handy Remover set

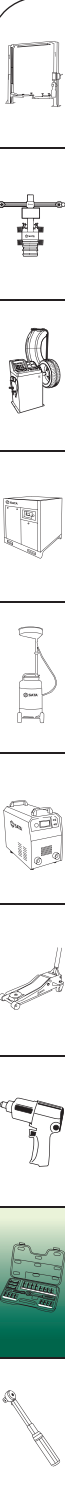

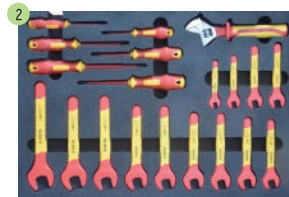

- 1 pc 12508 3/8" Dr. 6pt. VDE Insulation Socket 8MM
- 1 pc 12510 3/8" Dr. 6pt. VDE Insulation Socket 10MM
- 1 pc 12512 3/8" Dr. 6pt. VDE Insulation Socket 12MM
- 1 pc 12513 3/8" Dr. 6pt. VDE Insulation Socket 13MM
- 1 pc 12514 3/8" Dr. 6pt. VDE Insulation Socket 14MM
- 1 pc 12516 3/8" Dr. 6pt. VDE Insulation Socket 16MM
- 1 pc 12517 3/8" Dr. 6pt. VDE Insulation Socket 17MM
- 1 pc 12518 3/8" Dr. 6pt. VDE Insulation Socket 18MM
- 1 pc 12941 3/8" Dr. VDE Insulation Extension Bar 125MM
- 1 pc 12942 3/8" Dr. VDE Insulation Extension Bar 250MM
- 1 pc 12982 3/8" Dr. VDE Insulation Quick Release Ratchet with Grip 200MM
- 1 pc 12983 1/2" Dr. VDE Insulation Quick Release Ratchet with Grip 250MM
- 1 pc 12984 1/2" Dr. VDE Insulation T-type Driver 200MM
- 1 pc 12985 1/2" Dr. VDE Insulation Extension Bar 125MM
- 1 pc 12986 1/2" Dr. VDE Insulation Extension Bar 250MM
- 1 pc 14010 1/2" Dr. 6pt. VDE Insulation Socket 10MM
- 1 pc 14011 1/2" Dr. 6pt. VDE Insulation Socket 11MM
- 1 pc 14012 1/2" Dr. 6pt. VDE Insulation Socket 12MM
- 1 pc 14013 1/2" Dr. 6pt. VDE Insulation Socket 13MM
- 1 pc 14014 1/2" Dr. 6pt. VDE Insulation Socket 14MM
- 1 pc 14016 1/2" Dr. 6pt. VDE Insulation Socket 16MM
- 1 pc 14017 1/2" Dr. 6pt. VDE Insulation Socket 17MM
- 1 pc 14019 1/2" Dr. 6pt. VDE Insulation Socket 19MM
- 1 pc 14021 1/2" Dr. 6pt. VDE Insulation Socket 21MM
- 1 pc 14022 1/2" Dr. 6pt. VDE Insulation Socket 22MM
- 1 pc 14024 1/2" Dr. 6pt. VDE Insulation Socket 24MM
- 1 pc 24404 1/2" Dr. VDE Insulation Bits Socket, Hexagon 4MM
- 1 pc 24405 1/2" Dr. VDE Insulation Bits Socket, Hexagon 5MM
- 1 pc 24406 1/2" Dr. VDE Insulation Bits Socket, Hexagon 6MM
- 1 pc 24408 1/2" Dr. VDE Insulation Bits Socket, Hexagon 8MM
- 1 pc 24410 1/2" Dr. VDE Insulation Bits Socket, Hexagon 10MM
- 1 pc 41308 VDE Insulation Open End Wrench 8MM
- 1 pc 41310 VDE Insulation Open End Wrench 10MM
- 1 pc 41312 VDE Insulation Open End Wrench 12MM
- 1 pc 41313 VDE Insulation Open End Wrench 13MM
- 1 pc 41314 VDE Insulation Open End Wrench 14MM
- 1 pc 41315 VDE Insulation Open End Wrench 15MM
- 1 pc 41316 VDE Insulation Open End Wrench 16MM
- 1 pc 41317 VDE Insulation Open End Wrench 17MM
- 1 pc 41318 VDE Insulation Open End Wrench 18MM
- 1 pc 41319 VDE Insulation Open End Wrench 19MM
- 1 pc 41321 VDE Insulation Open End Wrench 21MM
- 1 pc 41322 VDE Insulation Open End Wrench 22MM
- 1 pc 41324 VDE Insulation Open End Wrench 24MM
- 1 pc 42408 VDE Insulation Box End Wrench 8MM
- 1 pc 42410 VDE Insulation Box End Wrench 10MM
- 1 pc 42412 VDE Insulation Box End Wrench 12MM
- 1 pc 42413 VDE Insulation Box End Wrench 13MM
- 1 pc 42414 VDE Insulation Box End Wrench 14MM
- 1 pc 42415 VDE Insulation Box End Wrench 15MM
- 1 pc 42416 VDE Insulation Box End Wrench 16MM
- 1 pc 42417 VDE Insulation Box End Wrench 17MM
- 1 pc 42418 VDE Insulation Box End Wrench 18MM
- 1 pc 42419 VDE Insulation Box End Wrench 19MM
- 1 pc 42421 VDE Insulation Box End Wrench 21MM
- 1 pc 42422 VDE Insulation Box End Wrench 22MM
- 1 pc 42424 VDE Insulation Box End Wrench 24MM
- 1 pc 47102 VDE Insulated Adjustable Wrench 8"
- 1 pc 61221 T Series VDE Insulated Screwdriver, Phillips #0x60MM
- 1 pc 61222 T Series VDE Insulated Screwdriver, Phillips #1x80MM
- 1 pc 61223 T Series VDE Insulated Screwdriver, Phillips #2x100MM
- 1 pc 61321 T Series VDE Insulated Screwdriver, Phillips #2.5x75MM
- 1 pc 61323 T Series VDE Insulated Screwdriver, Phillips #4x100MM
- 1 pc 61324 T Series VDE Insulated Screwdriver, Phillips #5.5x125MM
- 1 pc 70132 VDE Insulated Long Nose Pliers 8"
- 1 pc 70233 VDE Insulated Diagonal Pliers 7"
- 1 pc 70333 VDE Insulated Combination Pliers 8"
- 1 pc 93470 VDE Insulated Cable Knife, Blade Protector



- One-station MRO tools solution for BMW, satisfy the daily demands of new workshop;
- EVA mats design, environmentally-friendly and healthy;
- Organized, not easily lost;
- SATA high quality tools, lifetime warranty.

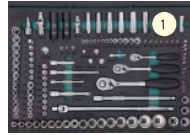

**First Layer**

Product Name
1/4" DR. 6PT. SOCKET 4MM
1/4" DR. 6PT. SOCKET 4.5MM
1/4" DR. 6PT. SOCKET 5MM
1/4" DR. 6PT. SOCKET 5.5MM
1/4" DR. 6PT. SOCKET 6MM
1/4" DR. 6PT. SOCKET 7MM
1/4" DR. 6PT. SOCKET 8MM
1/4" DR. 6PT. SOCKET 9MM
1/4" DR. 6PT. SOCKET 10MM
1/4" DR. 6PT. SOCKET 11MM
1/4" DR. 6PT. SOCKET 12MM
1/4" DR. 6PT. SOCKET 13MM
1/4" DR. 6PT. SOCKET 14MM
1/4" DR. EXTENSION BAR 2"
1/4" DR. EXTENSION BAR 4"
1/4" DR. QUICK RELEASE RATCHET W/GRIP 5"
UNIVERSAL JOINT, 1/4"FX1/4" M
SOCKET ADAPTOR, 1/4"FX3/8" M
1/4" DR. BIT SOCKET, TORX T8
1/4" DR. BIT SOCKET, TORX T10
1/4" DR. BIT SOCKET, TORX T15
1/4" DR. BIT SOCKET, TORX T20
1/4" DR. BIT SOCKET, TORX T25
1/4" DR. BIT SOCKET, TORX T30
1/4" DR. BIT SOCKET, TORX T40
1/4" DR. BIT SOCKET, HEXAGON 3MM
1/4" DR. BIT SOCKET, HEXAGON 4MM
1/4" DR. BIT SOCKET, HEXAGON 5MM
1/4" DR. BIT SOCKET, HEXAGON 6MM
1/4" DR. BIT SOCKET, HEXAGON 7MM
1/4" DR. BIT SOCKET, HEXAGON 8MM

Product Name
1/4" DR. BIT SOCKET, PHILLIPS #1
1/4" DR. BIT SOCKET, PHILLIPS #2
1/4" DR. BIT SOCKET, PHILLIPS #3
1/4" DR. BIT SOCKET, SLOTTED 4MM
1/4" DR. BIT SOCKET, SLOTTED 5.5MM
1/4" DR. BIT SOCKET, SLOTTED 6.5MM
1/4" DR. 6PT. DEEP SOCKET 8MM
1/4" DR. 6PT. DEEP SOCKET 9MM
1/4" DR. 6PT. DEEP SOCKET 10MM
1/4" DR. 6PT. DEEP SOCKET 12MM
1/4" DR. TORX SOCKET E4
1/4" DR. TORX SOCKET E6
1/4" DR. TORX SOCKET E8
3/8" DR. 6PT. SOCKET 6MM
3/8" DR. 6PT. SOCKET 7MM
3/8" DR. 6PT. SOCKET 8MM
3/8" DR. 6PT. SOCKET 9MM
3/8" DR. 6PT. SOCKET 10MM
3/8" DR. 6PT. SOCKET 11MM
3/8" DR. 6PT. SOCKET 12MM
3/8" DR. 6PT. SOCKET 13MM
3/8" DR. 6PT. SOCKET 14MM
3/8" DR. 6PT. SOCKET 15MM
3/8" DR. 6PT. SOCKET 16MM
3/8" DR. 6PT. SOCKET 17MM
3/8" DR. 6PT. SOCKET 18MM
3/8" DR. 6PT. DEEP SOCKET 19MM
3/8" DR. EXTENSION BAR 3"
3/8" DR. EXTENSION BAR 6"
3/8" DR. TORX SOCKET E10
3/8" DR. TORX SOCKET E11

Product Name
3/8" DR. TORX SOCKET E12
3/8" DR. TORX SOCKET E14
3/8" DR. TORX SOCKET E16
3/8" DR. TORX SOCKET E18
3/8" DR. BIT SOCKET, HEXAGON 3MM
3/8" DR. BIT SOCKET, HEXAGON 4MM
3/8" DR. BIT SOCKET, HEXAGON 5MM
3/8" DR. BIT SOCKET, HEXAGON 6MM
3/8" DR. BIT SOCKET, HEXAGON 7MM
3/8" DR. BIT SOCKET, HEXAGON 8MM
3/8" DR. BIT SOCKET, HEXAGON 10MM
3/8" DR. BIT SOCKET, TORX T15
3/8" DR. BIT SOCKET, TORX T20
3/8" DR. BIT SOCKET, TORX T25
3/8" DR. BIT SOCKET, TORX T27
3/8" DR. BIT SOCKET, TORX T30
3/8" DR. BIT SOCKET, TORX T40
3/8" DR. BIT SOCKET, TORX T45
3/8" DR. BIT SOCKET, TORX T50
3/8" DR. BIT SOCKET, TORX T55
3/8" DR. QUICK RELEASE RATCHET W/GRIP 8"
UNIVERSAL JOINT, 3/8"FX3/8" M
SOCKET ADAPTOR, 3/8"FX1/2" M
3/8" DR. SPARK PLUG SOCKET 16MM
3/8" DR. 12PT./W SPARK SOCKET 14MM
3/8" DR. 6PT. DEEP SOCKET 13MM
3/8" DR. 6PT. DEEP SOCKET 14MM
3/8" DR. 6PT. DEEP SOCKET 15MM
3/8" DR. 6PT. DEEP SOCKET 17MM
1/2" DR.12PT. SOCKET 10MM

Product Name
1/2" DR.12PT. SOCKET 11MM
1/2" DR.12PT. SOCKET 12MM
1/2" DR.12PT. SOCKET 13MM
1/2" DR.12PT. SOCKET 14MM
1/2" DR.12PT. SOCKET 15MM
1/2" DR.12PT. SOCKET 16MM
1/2" DR.12PT. SOCKET 17MM
1/2" DR.12PT. SOCKET 18MM
1/2" DR.12PT. SOCKET 19MM
1/2" DR.12PT. SOCKET 21MM
1/2" DR.12PT. SOCKET 22MM
1/2" DR.12PT. SOCKET 24MM
1/2" DR.12PT. SOCKET 27MM
1/2" DR.12PT. SOCKET 30MM
1/2" DR.12PT. SOCKET 32MM
1/2" DR. QUICK RELEASE RATCHET W/GRIP10"
1/2" DR. EXTENSION BAR 5"
1/2" DR. EXTENSION BAR 10"
UNIVERSAL JOINT, 1/2"FX1/2" M
SOCKET ADAPTOR, 1/2"FX3/8" M
1/2" DR. TORX SOCKET E18
1/2" DR. TORX SOCKET E20
1/2" DR. TORX SOCKET E22
1/2" DR. TORX SOCKET E24
1/2" DR. BIT SOCKET, 50MM, TORX T55
1/2" Dr 6pt T/W Impact Deep Socket 17MM
1/2" Dr 6pt T/W Impact Deep Socket 19MM
1/2" DR. BIT SOCKET, 100MM, HEX 7MM

**Second Layer**

Product Name
FULL POLISH COMBINATION WRENCH 8MM
FULL POLISH COMBINATION WRENCH 9MM
FULL POLISH COMBINATION WRENCH 10MM
FULL POLISH COMBINATION WRENCH 11MM
FULL POLISH COMBINATION WRENCH 12MM
FULL POLISH COMBINATION WRENCH 13MM
FULL POLISH COMBINATION WRENCH 14MM
FULL POLISH COMBINATION WRENCH 15MM
FULL POLISH COMBINATION WRENCH 16MM

Product Name
FULL POLISH COMBINATION WRENCH 17MM
FULL POLISH COMBINATION WRENCH 18MM
FULL POLISH COMBINATION WRENCH 19MM
FULL POLISH COMBINATION WRENCH 20MM
FULL POLISH COMBINATION WRENCH 21MM
FULL POLISH COMBINATION WRENCH 22MM
FULL POLISH COMBINATION WRENCH 23MM
FULL POLISH COMBINATION WRENCH 24MM
FULL POLISH COMBINATION WRENCH 25MM

Product Name
FULL POLISH COMBINATION WRENCH 27MM
FP BOX END RATCHETING WRENCH 8X10MM
FP BOX END RATCHETING WRENCH 12X13MM
FP BOX END RATCHETING WRENCH 14X15MM
FP BOX END RATCHETING WRENCH 16X18MM
FP BOX END RATCHETING WRENCH 17X19MM
END CAP OIL FILTER WRENCH 87MM
END CAP OIL FILTER WRENCH 36MM
FULL POLISH FLARE NUT WRENCH 9X11MM

Product Name
FULL POLISH FLARE NUT WRENCH 1X12MM
1/2" DR. BIT SOCKET, 100MM, TORX T50
1/2" DR. BIT SOCKET, 100MM, TORX T55
1/2" DR. BIT SOCKET, 100MM, TORX T60
1/2" DR. BIT SOCKET, 50MM, HEX 7MM
1/2" DR. BIT SOCKET, 100MM, HEX 7MM

**Third Layer**

Product Name
A SERIES REWDRIVER, TORX T8X75MM
A SERIES REWDRIVER, TORX T10X100MM
A SERIES REWDRIVER, TORX T15X100MM
A SERIES REWDRIVER, TORX T2X100MM
A SERIES REWDRIVER, TORX T25X100MM
A SERIES REWDRIVER, TORX T27X100MM
A SERIES REWDRIVER, TORX T3X100MM
A SERIES REWDRIVER, TORX T4X100MM
A SERIES REWDRIVER, SLOTTED 3.2X75MM
A SERIES REWDRIVER, SLOTTED 5X75MM
A SERIES REWDRIVER, SLOTTED 6X150MM
A SERIES REWDRIVER, PHILLIPS #0X75MM
A SERIES REWDRIVER, PHILLIPS #1X75MM
A SERIES REWDRIVER, PHILLIPS #2X150MM

Product Name
A SERIES REWDRIVER, SLOTTED 5X300MM
A SERIES REWDRIVER, PHILLIPS #2X300MM
A SERIES GO THROUGH SD,SL6X150MM
A SERIES GO THROUGH SD,PH#2X150MM
10PC. EXTRA LONG BALL POINT HEX KEY SET
9PC. LONG ARM TORX KEY SET
MULTI-USE ISSORS 8"
5PCS PUNCH SET
14PC. FEELER GAUGES SET 0.05-1.00MM
FLEXIBLE MEGNETIC PICKUP TOOL 400MMX1KG
Screwdriver
LONG NOSE PLIERS 6"
GROOVE JOINT PLIERS 10"

**Fourth Layer**

Product Name
AIR BLOW GUN + BRASS AIR INLET 250mm
COMBINATION PLIERS 7"
DIAGONAL PLIERS 6"
SLIP JOINT PLIERS 8"
10" CURVED JAW LOCKING PLIER W/CUT
GER. EXTER. SNAP RING PLIER 7" STRAIGHT
GER. INTER. SNAP RING PLIER 7" STRAIGHT
ABS CASE TAPE MEASURE 5MX19MM
FIBERGLASS HANDLE BALL PEIN HAMMER 1.5LB
DEAD BLOW HAMMER 55MM
PLASTIC SNAP-OFF KNIFE, 13-POINT, 9X80MM
5 PC. WITHDRAWAL TOOLS FOR INTERIOR TRIM

⚠ The tools set customized for all MERCEDES-BENZ Models on sale



09925 210PC DR. MASTER TOOL SET FOR MERCEDES-BENZ WITH 4 DRAWERS TROLLEY 95125



- One-station MRO tools solution for MERCEDES-BENZ, satisfy the daily demands of new workshop;
- EVA mats design, environmentally-friendly and healthy;
- Organized, not easily lost;
- SATA high quality tools, lifetime warranty.

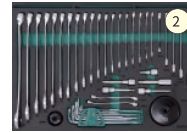
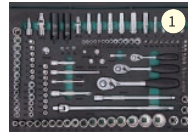

**First Layer**

Product Name
1/2" DR.12PT. SOCKET 12MM
1/2" DR.12PT. SOCKET 13MM
1/2" DR.12PT. SOCKET 14MM
1/2" DR.12PT. SOCKET 15MM
1/2" DR.12PT. SOCKET 16MM
1/2" DR.12PT. SOCKET 17MM
1/2" DR.12PT. SOCKET 18MM
1/2" DR.12PT. SOCKET 19MM
1/2" DR.12PT. SOCKET 21MM
1/2" DR.12PT. SOCKET 22MM
1/2" DR.12PT. SOCKET 24MM
1/2" DR.12PT. SOCKET 26MM
1/2" DR.12PT. SOCKET 27MM
1/2" DR.12PT. SOCKET 30MM
1/2" DR.12PT. SOCKET 32MM
3/8" DR. 6PT. DEEP SOCKET 8MM
3/8" DR. 6PT. DEEP SOCKET 10MM
3/8" DR. 6PT. DEEP SOCKET 11MM
3/8" DR. 6PT. DEEP SOCKET 12MM
3/8" DR. 6PT. DEEP SOCKET 13MM
3/8" DR. 6PT. DEEP SOCKET 14MM
3/8" DR. 6PT. DEEP SOCKET 15MM
3/8" DR. 6PT. DEEP SOCKET 17MM
3/8" DR. 6PT. DEEP SOCKET 19MM
1/4" DR. 6PT. SOCKET 6MM
1/4" DR. 6PT. SOCKET 7MM

Product Name
1/4" DR. 6PT. SOCKET 8MM
1/4" DR. 6PT. SOCKET 9MM
1/4" DR. 6PT. SOCKET 10MM
1/4" DR. 6PT. SOCKET 11MM
1/4" DR. 6PT. SOCKET 12MM
1/4" DR. 6PT. SOCKET 13MM
1/4" DR. 6PT. SOCKET 14MM
1/4" DR. BIT SOCKET, TORX T10
1/4" DR. BIT SOCKET, TORX T15
1/4" DR. BIT SOCKET, TORX T20
1/4" DR. BIT SOCKET, TORX T25
1/4" DR. BIT SOCKET, TORX T30
1/4" DR. BIT SOCKET, HEXAGON 3MM
1/4" DR. BIT SOCKET, HEXAGON 4MM
1/4" DR. BIT SOCKET, HEXAGON 5MM
1/4" DR. BIT SOCKET, HEXAGON 6MM
1/4" DR. BIT SOCKET, HEXAGON 7MM
1/4" DR. BIT SOCKET, HEXAGON 8MM
1/4" DR. BIT SOCKET, PHILLIPS #1
1/4" DR. BIT SOCKET, PHILLIPS #2
1/4" DR. BIT SOCKET, PHILLIPS #3
1/4" DR. QUICK RELEASE RATCHET W/GRIP 5"
1/4" DR. EXTENSION BAR 2"
1/4" DR. EXTENSION BAR 4"
UNIVERSAL JOINT, 1/4"FX1/4"M
3/8" DR. QUICK RELEASE RATCHET W/GRIP 8"

Product Name
3/8" DR. EXTENSION BAR 3"
3/8" DR. EXTENSION BAR 6"
UNIVERSAL JOINT, 3/8"FX3/8"M
SOCKET ADAPTOR, 3/8"FX1/4"M
SOCKET ADAPTOR, 3/8"FX1/2"M
1/2" DR. QUICK RELEASE RATCHET W/GRIP10"
1/2" DR. EXTENSION BAR 5"
1/2" DR. EXTENSION BAR 10"
UNIVERSAL JOINT, 1/2"FX1/2"M
SOCKET ADAPTOR, 1/2"FX3/8"M
3/8" DR. BIT SOCKET, HEXAGON 3MM
3/8" DR. BIT SOCKET, HEXAGON 4MM
3/8" DR. BIT SOCKET, HEXAGON 5MM
3/8" DR. BIT SOCKET, HEXAGON 6MM
3/8" DR. BIT SOCKET, HEXAGON 7MM
3/8" DR. BIT SOCKET, HEXAGON 8MM
3/8" DR. BIT SOCKET, HEXAGON 10MM
3/8" DR. BIT SOCKET, TORX T10
3/8" DR. BIT SOCKET, TORX T15
3/8" DR. BIT SOCKET, TORX T20
3/8" DR. BIT SOCKET, TORX T25
3/8" DR. BIT SOCKET, TORX T27
3/8" DR. BIT SOCKET, TORX T30
3/8" DR. BIT SOCKET, TORX T40
3/8" DR. BIT SOCKET, TORX T45
3/8" DR. BIT SOCKET, TORX T50

Product Name
1/2" DR. BIT SOCKET, 50MM , TORX T55
1/4" DR. TORX SOCKET E4
1/4" DR. TORX SOCKET E6
1/4" DR. TORX SOCKET E8
3/8" DR. TORX SOCKET E6
3/8" DR. TORX SOCKET E8
3/8" DR. TORX SOCKET E10
3/8" DR. TORX SOCKET E12
3/8" DR. TORX SOCKET E14
3/8" DR. TORX SOCKET E14
1/2" DR. TORX SOCKET E16
1/2" DR. TORX SOCKET E18
1/2" DR. TORX SOCKET E20
1/2" DR. TORX SOCKET E22
1/2" DR. TORX SOCKET E24
1/2" Dr 6pt 1/W Impact Deep Socket 17MM
1/2" Dr 6pt 1/W Impact Deep Socket 19MM
3/8" DR. SPARK PLUG SOCKET 16MM
3/8" DR. 12PTT/W SPARK SOCKET 14MM
1/2" DR. FLEX HANDLE 15"
1/2" DR. BIT SOCKET, 100MM , TORX T30
1/2" DR. BIT SOCKET, 100MM , TORX T40
1/2" DR. BIT SOCKET, 100MM , TORX T45
1/2" DR. BIT SOCKET, 100MM , TORX T55

**Second Layer**

Product Name
FULL POLISH COMBINATION WRENCH 8MM
FULL POLISH COMBINATION WRENCH 9MM
FULL POLISH COMBINATION WRENCH 10MM
FULL POLISH COMBINATION WRENCH 11MM
FULL POLISH COMBINATION WRENCH 12MM
FULL POLISH COMBINATION WRENCH 13MM
FULL POLISH COMBINATION WRENCH 14MM
FULL POLISH COMBINATION WRENCH 15MM

Product Name
FULL POLISH COMBINATION WRENCH 16MM
FULL POLISH COMBINATION WRENCH 17MM
FULL POLISH COMBINATION WRENCH 18MM
FULL POLISH COMBINATION WRENCH 19MM
FULL POLISH COMBINATION WRENCH 20MM
FULL POLISH COMBINATION WRENCH 21MM
FULL POLISH COMBINATION WRENCH 22MM
FULL POLISH COMBINATION WRENCH 23MM

Product Name
FULL POLISH COMBINATION WRENCH 24MM
FULL POLISH COMBINATION WRENCH 25MM
FULL POLISH COMBINATION WRENCH 27MM
FULL POLISH TORX WRENCH E6XE8
FULL POLISH TORX WRENCH E10XE12
FULL POLISH TORX WRENCH E14XE18
FP COMBINATION RATCHETING WRENCH 8MM
FP COMBINATION RATCHETING WRENCH 10MM

Product Name
FP COMBINATION RATCHETING WRENCH 12MM
FP COMBINATION RATCHETING WRENCH 14MM
FP COMBINATION RATCHETING WRENCH 16MM
FP COMBINATION RATCHETING WRENCH 18MM
FP COMBINATION RATCHETING WRENCH 21MM
OIL FILTER WRENCH 76-14
OIL FILTER WRENCH 84-14
10PC. EXTRA LONG BALL POINT HEX KEY SET

**Third Layer**

Product Name
A SERIES REWDRIWER, TORX T8X75MM
A SERIES REWDRIWER, TORX T10X100MM
A SERIES REWDRIWER, TORX T15X100MM
A SERIES REWDRIWER, TORX T2X100MM
A SERIES REWDRIWER, TORX T25X100MM
A SERIES REWDRIWER, TORX T27X100MM
A SERIES REWDRIWER, TORX T3X100MM
A SERIES REWDRIWER, TORX T4X100MM
A SERIES REWDRIWER, SLOTTED 3.2X75MM
A SERIES REWDRIWER, SLOTTED 5X75MM
A SERIES REWDRIWER, SLOTTED 6X150MM
A SERIES REWDRIWER, PHILLIPS #0X75MM
A SERIES REWDRIWER, PHILLIPS #1X75MM

Product Name
A SERIES REWDRIWER, PHILLIPS #2X150MM
A SERIES REWDRIWER, SLOTTED 5X300MM
A SERIES REWDRIWER, PHILLIPS #2X300MM
A SERIES GO THROUGH SD,SL6X150MM
A SERIES GO THROUGH SD,PH#2X150MM
9PC. LONG ARM TORX KEY SET
MULTI-USE ISSORS 8"
5PCS PUNCH SET
14PC. FEELER GAUGES SET 0.05-1.00MM
FLEXIBLE MEGNETIC PICKUP TOOL 400MMX1KG
Screwdriver
LONG NOSE PLIERS 6"
GROOVE JOINT PLIERS 10"

**Fourth Layer**

Product Name
AIR BLOW GUN + BRASS AIR INLET 250mm
COMBINATION PLIERS 7"
DIAGONAL PLIERS 6"
SLIP JOINT PLIERS 8"
10" CURVED JAW LOCKING PLIER W/CUT
GER. EXTER. SNAP RING PLIER 7" STRAIGHT
GER. INTER. SNAP RING PLIER 7" STRAIGHT
ABS CASE TAPE MEASURE 5MX19MM
FIBERGLASS HANDLE BALL PEIN HAMMER 1.5LB
DEAD BLOW HAMMER 55MM
PLASTIC SNAP-OFF KNIFE, 13-POINT, 9X80MM
5 PC. WITHDRAWAL TOOLS FOR INTERIOR TRIM

▲ The tools set customized for all MERCEDES-BENZ Models on sale

09930 249PC DR. MASTER TOOL SET FOR BODY REPAIR WITH 6 DRAWERS TROLLEY 95126



- One-station Car body repair tools solution, satisfy the daily demands of new workshop;
- EVA mats design, environmentally-friendly and healthy;
- Organized, not easily lost;
- SATA high quality tools, lifetime warranty.



**First Layer**

Product Name
1/2" DR. 6PT SOCKET 8MM
1/2" DR. 6PT SOCKET 9MM
1/2" DR. 6PT SOCKET 10MM
1/2" DR. 6PT SOCKET 11MM
1/2" DR. 6PT SOCKET 12MM
1/2" DR. 6PT SOCKET 13MM
1/2" DR. 6PT SOCKET 14MM
1/2" DR. 6PT SOCKET 15MM
1/2" DR. 6PT SOCKET 16MM
1/2" DR. 6PT SOCKET 17MM
1/2" DR. 6PT SOCKET 18MM
1/2" DR. 6PT SOCKET 19MM
1/2" DR. 6PT SOCKET 20MM
1/2" DR. 6PT SOCKET 21MM
1/2" DR. 6PT SOCKET 22MM
1/2" DR. 6PT SOCKET 23MM
1/2" DR. 6PT SOCKET 24MM
1/2" DR. 6PT SOCKET 27MM
1/2" DR. 6PT SOCKET 30MM
1/2" DR. 6PT SOCKET 32MM
3/8" DR. 6PT DEEP SOCKET 10MM
3/8" DR. 6PT DEEP SOCKET 11MM
3/8" DR. 6PT DEEP SOCKET 12MM
3/8" DR. 6PT DEEP SOCKET 13MM
3/8" DR. 6PT DEEP SOCKET 14MM
3/8" DR. 6PT DEEP SOCKET 15MM
3/8" DR. 6PT DEEP SOCKET 16MM
3/8" DR. 6PT DEEP SOCKET 17MM
3/8" DR. 6PT DEEP SOCKET 18MM
3/8" DR. 6PT DEEP SOCKET 19MM
3/8" DR. 6PT DEEP SOCKET 20MM
3/8" DR. 6PT DEEP SOCKET 21MM
3/8" DR. 6PT DEEP SOCKET 22MM
3/8" DR. 6PT DEEP SOCKET 23MM
3/8" DR. 6PT DEEP SOCKET 24MM
3/8" DR. 6PT DEEP SOCKET 27MM
3/8" DR. 6PT DEEP SOCKET 30MM
3/8" DR. 6PT DEEP SOCKET 32MM

Product Name
3/8" DR. 6PT SOCKET 9MM
3/8" DR. 6PT SOCKET 10MM
3/8" DR. 6PT SOCKET 11MM
3/8" DR. 6PT SOCKET 12MM
3/8" DR. 6PT SOCKET 13MM
3/8" DR. 6PT SOCKET 14MM
3/8" DR. 6PT SOCKET 15MM
3/8" DR. 6PT SOCKET 16MM
3/8" DR. 6PT SOCKET 17MM
3/8" DR. 6PT SOCKET 18MM
3/8" DR. 6PT SOCKET 19MM
1/4" DR. 6PT SOCKET 4MM
1/4" DR. 6PT SOCKET 4.5MM
1/4" DR. 6PT SOCKET 5MM
1/4" DR. 6PT SOCKET 5.5MM
1/4" DR. 6PT SOCKET 6MM
1/4" DR. 6PT SOCKET 7MM
1/4" DR. 6PT SOCKET 8MM
1/4" DR. 6PT SOCKET 9MM
1/4" DR. 6PT SOCKET 10MM
1/4" DR. 6PT SOCKET 11MM
1/4" DR. 6PT SOCKET 12MM
1/4" DR. 6PT SOCKET 13MM
1/4" DR. 6PT SOCKET 14MM
1/4" DR. QUICK RELEASE RATCHET W/GRIP 5"
3/8" DR. QUICK RELEASE RATCHET W/GRIP 8"
1/2" DR. QUICK RELEASE RATCHET W/GRIP10"
1/2" DR. L-SHAPED WRENCH 10"
1/4" DR. EXTENSION BAR 2"
1/4" DR. EXTENSION BAR 4"
3/8" DR. EXTENSION BAR 3"
3/8" DR. EXTENSION BAR 6"
1/2" DR. EXTENSION BAR 5"
1/2" DR. EXTENSION BAR 10"

Product Name
UNIVERSAL JOINT, 1/4"FX1/4" M
UNIVERSAL JOINT, 3/8"FX3/8" M
UNIVERSAL JOINT, 1/2"FX1/2" M
1/4" FLEX EXTENSION 6" (SATA#11922)
SOCKET ADAPTOR, 3/8"FX1/4" M
SOCKET ADAPTOR, 3/8"FX1/2" M
SOCKET ADAPTOR, 1/2"FX3/8" M
3/8" DR. 12PTIT/W SPARK SOCKET 14MM
3/8" DR. SPARK PLUG SOCKET 16MM
3/8" DR. SPARK PLUG SOCKET 21MM
5PC. 8MM HEX BITS, 30MM, SLOTTED 5.5MM
5PC. 8MM HEX BITS, 30MM, SLOTTED 6.5MM
5PC. 8MM HEX BITS, 30MM, SLOTTED 8MM
5PC. 8MM HEX BITS, 30MM, SLOTTED 10MM
5PC. 8MM HEX BITS, 30MM, SLOTTED 12MM
Tap Adaptor M3-M4
Tap Adaptor M5-M12
Die Adaptor M3-M12
21PC. HSS COARSE THREAD TAP SET
5PC. 8MM HEX BITS, 30MM, RESISTORX TT25
5PC. 8MM HEX BITS, 30MM, RESISTORX TT30
5PC. 8MM HEX BITS, 30MM, RESISTORX TT40
5PC. 8MM HEX BITS, 30MM, RESISTORX TT45
5PC. 8MM HEX BITS, 30MM, RESISTORX TT50
5PC. 8MM HEX BITS, 30MM, RESISTORX TT55
5PC. 8MM HEX BITS, 30MM, RESISTORX TT60
5PC. 8MM HEX BITS, 30MM, 12PT. M5
5PC. 8MM HEX BITS, 30MM, 12PT. M6
5PC. 8MM HEX BITS, 30MM, 12PT. M8
5PC. 8MM HEX BITS, 30MM, 12PT. M10
5PC. 8MM HEX BITS, 30MM, 12PT. M12
5PC. 8MM HEX BITS, 30MM, 12PT. M16
5PC. 8MM HEX BITS, 70MM, HEXAGON 4MM
5PC. 8MM HEX BITS, 70MM, HEXAGON 5MM
5PC. 8MM HEX BITS, 70MM, HEXAGON 6MM
5PC. 8MM HEX BITS, 70MM, HEXAGON 7MM
5PC. 8MM HEX BITS, 70MM, HEXAGON 8MM
5PC. 8MM HEX BITS, 70MM, HEXAGON 10MM
5PC. 8MM HEX BITS, 70MM, HEXAGON 12MM
5PC. 8MM HEX BITS, 70MM, HEXAGON 14MM
BIT ADAPTOR, 1/2"FX5/16" HEX
BIT ADAPTOR, 3/8"FX5/16"HEX

Product Name
5PC. 8MM HEX BITS, 30MM, HEXAGON 7MM
5PC. 8MM HEX BITS, 30MM, HEXAGON 8MM
5PC. 8MM HEX BITS, 30MM, HEXAGON 10MM
5PC. 8MM HEX BITS, 30MM, HEXAGON 12MM
5PC. 8MM HEX BITS, 70MM, SLOTTED 8MM
5PC. 8MM HEX BITS, 70MM, PHILLIPS #2
5PC. 8MM HEX BITS, 70MM, TORX T20
5PC. 8MM HEX BITS, 70MM, TORX T25
5PC. 8MM HEX BITS, 70MM, TORX T27
5PC. 8MM HEX BITS, 70MM, TORX T30
5PC. 8MM HEX BITS, 70MM, TORX T40
5PC. 8MM HEX BITS, 70MM, TORX T45
5PC. 8MM HEX BITS, 70MM, TORX T50
5PC. 8MM HEX BITS, 70MM, TORX T55
5PC. 8MM HEX BITS, 70MM, 12PT. M5
5PC. 8MM HEX BITS, 70MM, 12PT. M6
5PC. 8MM HEX BITS, 70MM, 12PT. M8
5PC. 8MM HEX BITS, 70MM, 12PT. M10
5PC. 8MM HEX BITS, 70MM, 12PT. M12
5PC. 8MM HEX BITS, 70MM, 12PT. M14
5PC. 8MM HEX BITS, 70MM, 12PT. M16
5PC. 8MM HEX BITS, 70MM, HEXAGON 4MM
5PC. 8MM HEX BITS, 70MM, HEXAGON 5MM
5PC. 8MM HEX BITS, 70MM, HEXAGON 6MM
5PC. 8MM HEX BITS, 70MM, HEXAGON 7MM
5PC. 8MM HEX BITS, 70MM, HEXAGON 8MM
5PC. 8MM HEX BITS, 70MM, HEXAGON 10MM
5PC. 8MM HEX BITS, 70MM, HEXAGON 12MM
5PC. 8MM HEX BITS, 70MM, HEXAGON 14MM
BIT ADAPTOR, 1/2"FX5/16" HEX
BIT ADAPTOR, 3/8"FX5/16"HEX

**Second Layer**

Product Name
GER. EXTER. SNAP RING PLIER 7" STRAIGHT
GER. EXTER. SNAP RING PLIER 7" CURVED
GER. INTER. SNAP RING PLIER 7" STRAIGHT
GER. INTER. SNAP RING PLIER 7" CURVED
LONG NOSE PLIERS 6"
DIAGONAL PLIERS 6"
COMBINATION PLIERS 8"
SLIP JOINT PLIERS 8"
10" CURVED JAW LOCKING PLIER W/CUT
A SERIES GO THROUGH SD,SL6x150MM
A SERIES GO THROUGH SD,PH#2x150MM
A SERIES REWDRIWER, SLOTTED 3.2X75MM
A SERIES REWDRIWER, SLOTTED 5X100MM
A SERIES REWDRIWER, SLOTTED 6X38MM
A SERIES REWDRIWER, SLOTTED 6X100MM
A SERIES REWDRIWER, PHILLIPS #0X75MM
A SERIES REWDRIWER, PHILLIPS #1X75MM
A SERIES REWDRIWER, PHILLIPS #2X38MM
A SERIES REWDRIWER, PHILLIPS #2X100MM

**Third Layer**

Product Name
FLEXIBLE MEGNETIC PICKUP TOOL 400MMX1KG
9PC. EXTRA LONG BALL POINT HEX KEY SET
9PC. LONG ARM TORX KEY SET
5PCS PUNCH SET
5PC. FINE THREADED EXTRACTOR SET
BIT SOCKET FOR ENGINE COVER REWS
1/2" DR. M16 OIL PAN BITS SOCKET
1/2" DR. H17 OIL PAN BITS SOCKET
AUTOMOTIVE CIRCUIT TESTER 6V/12V/24V
AIR BLOW GUN + BRASS AIR INLET 100mm
PLASTIC SNAP-OFF KNIFE, 13-POINT, 9X80MM
FIBERGLASS HANDLE BALL PEIN HAMMER 1.5LB
DEAD BLOW HAMMER 55MM
14PC. FEELER GAUGES SET 0.05-1.00MM
ABS CASE TAPE MEASURE 5MX19MM
UNIVERSAL 3-JAW OIL FILTER WRENCH
ADJUSTABLE WRENCH 10"
5 PC. WITHDRAWAL TOOLS FOR INTERIOR TRIM

**Fourth Layer**

Product Name
FULL POLISH COMBINATION WRENCH 8MM
FULL POLISH COMBINATION WRENCH 9MM
FULL POLISH COMBINATION WRENCH 10MM
FULL POLISH COMBINATION WRENCH 11MM
FULL POLISH COMBINATION WRENCH 12MM
FULL POLISH COMBINATION WRENCH 13MM
FULL POLISH COMBINATION WRENCH 14MM
FULL POLISH COMBINATION WRENCH 15MM
FULL POLISH COMBINATION WRENCH 16MM
FULL POLISH COMBINATION WRENCH 17MM
FULL POLISH COMBINATION WRENCH 18MM
FULL POLISH COMBINATION WRENCH 19MM
FULL POLISH COMBINATION WRENCH 20MM
FULL POLISH COMBINATION WRENCH 21MM
FULL POLISH COMBINATION WRENCH 22MM
FULL POLISH COMBINATION WRENCH 23MM
FULL POLISH COMBINATION WRENCH 24MM
FULL POLISH COMBINATION WRENCH 25MM
FULL POLISH COMBINATION WRENCH 27MM
FLAT FILE, SECOND 8"
HALF ROUND FILE, SECOND 8"
ROUND FILE, SECOND 8"
THREE SQUARE FILE, SECOND 8"
DIAMOND FLAT NEEDLE FILE 3X140MM
DP HALF ROUND NEEDLE FILE 3X140MM
DP ROUND NEEDLE FILE 3X140MM

**Fifth Layer**

Product Name
330G CURVED PEIN & FINISHING HAMMER
330G STRAIGHT PEIN & FINISHING HAMMER
260G PICK & FINISHING HAMMER
DOUBLE END HAND DOLLY
CURVED DOLLY
TOE DOLLY
SPOON DOLLY
CHISEL RAPER KNIFE
9" WELDING CLAMP LOCKING PLIERS
9" LONG NOSE LOCKING PLIERS
8" SHEET METAL CLAMP LOCKING PLIERS
11" C-CLAMP LOCKING PLIERS

▲ General repair tool set, can meet most demand of daily repair and maintenance in general repair shop and chained Store

09931 368PC DR. MASTER TOOL SET FOR GENERAL REPAIR WITH 6 DRAWERS TROLLEY 95126



- One-station MRO tools solution, satisfy the daily demands of new workshop;
- EVA mats design, environmentally-friendly and healthy;
- Organized, not easily lost;
- SATA high quality tools, lifetime warranty.

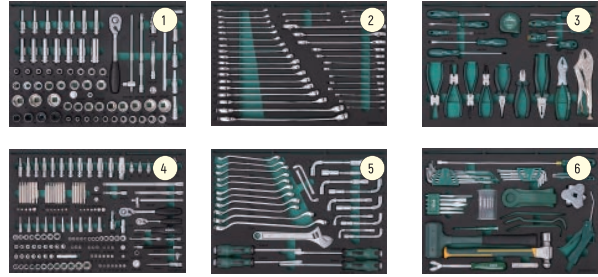

**First Layer**

Product Name
20 Pcs. 1/2" DR. 6PT. SOCKET (8,9,10,11,12,13,14,15,16,17,18,19,20,21,22,23,24,27,30,32MM)
14 Pcs. 1/2" DR. 6PT. DEEP SOCKET (10,11,12,13,14,15,16,17,18,19,20,21,22,24MM)
20 Pcs. 1/2" DR.12PT. SOCKET(8,9,10,11,12,13,14,15,16,17,18,19,20,21,22,23,24,27,30,32MM)
4 Pcs. 12.5MM DR. 12PT. DEEP SOCKET(10,12,13,14MM)
4 Pcs. 1/2" DR. 6PT. IMPACT SOCKET(17,19,21,23MM)
1 Pc. 1/2" DR. QUICK RELEASE RATCHET W/GRIP10"
1 Pc. 1/2" DR. L-SHAPED WRENCH 10"
1 Pc. 1/2" DR. SLIDING T-HANDLE 10"
1 Pc. UNIVERSAL JOINT, 1/2"FX1/2"M
1 Pc. SOCKET ADAPTOR, 1/2"FX3/8"M
1 Pc. 1/2" DR. SLIDING HEAD, 1/2"FX3/8"M
2 Pc. 1/2" DR. EXTENSION BAR 5", 10"
1 Pc. BIT ADAPTOR, 1/2"FX8MM HEX

**Second Layer**

Product Name
23PC. FULL POLISH COMBIANTION WRENCH SET (6,7,8,9,10,11,12,13,14,15,16,17,18,19,20,21,22,23,24,25,27,30,32MM)
13PC. FULL POLISH OPEN END WRENCH SET(6x7, 8x10,10x12,12x14,13x15,13x16,14x17,16x18,17x19,19x21,22x24,24x27,30x32MM)

**Third Layer**

Product Name
1 Pc GER. EXTER. SNAP RING PLIER 7" STRAIGHT
1 Pc GER. EXTER. SNAP RING PLIER 7" CURVED
1 Pc GER. INTER. SNAP RING PLIER 7" STRAIGHT
1 Pc GER. INTER. SNAP RING PLIER 7" CURVED
1 Pc LONG NOSE PLIERS 6"
1 Pc DIAGONAL PLIERS 6"
1 Pc COMBINATION PLIERS 8"
1 Pc SLIP JOINT PLIERS 8"
1 Pc 10" CURVED JAW LOCKING PLIER W/CUT
1 Pc A SERIES GO THROUGH SD.SL6x150MM
1 Pc A SERIES GO THROUGH SD.PH#2x150MM
4 Pc A SERIES SCREWDRIVER, SLOTTED(3,2X75,5x100,6x38,6x100MM)
4 Pc A SERIES REWDRIVER, PHILLIPS(#0x75,#1x75,#2x38,#2x100MM)
1 Pc ABS CASE TAPE MEASURE 5MX19MM

**Fourth Layer**

Product Name
7 PC. 8MM HEX BITS, 70MM, HEXAGON (4,5,6,7,8,10,12MM)
5 PC. 8MM HEX BITS, 70MM, 12PT(M5,M6,M8,M10,M12)
8 PC. 8MM HEX BITS, 70MM, TORX(T20,T25,T27,T30,T40,T45,T50,T55)
7 PC. 8MM HEX BITS, 30MM, HEXAGON(4,5,6,7,8,10,12MM)
5 PC. 8MM HEX BITS, 70MM, 12PT(M5,M6,M8,M10,M12)
6 PC. 8MM HEX BITS, 30MM, RESISTOR(TT20,TT25,TT30,TT40,TT45,TT50)
1 PC 10MM BIT ADAPTOR 5/16
12 PC. 3/8" DR. 6PT. SOCKET(8,9,10,11,12,13,14,15,16,17,18,19MM)
10 PC. 3/8" DR. 6PT. DEEP SOCKET(8,9,10,11,12,13,14,15,17,19MM)
8 PC. 3/8" DR. TORX SOCKET(E8,E10,E11,E12,E14,E16,E18,E20)
9 PC. 3/8" DR. BIT SOCKET(TT10,T15,T20,T25,T27,T30,T40,T45,T50)
7 PC. 3/8" DR. BIT SOCKET, HEXAGON(3,4,5,6,7,8,10MM)
3 PC. 3/8" DR. BIT SOCKET, PHILLIPS(#1,#2,#3)
2 PC. 3/8" DR. BIT SOCKET, SLOTTED(5,5,6,6MM)
13 PC. 1/4" DR. 6PT. SOCKET(4,4,5,5,5,5,6,7,8,9,10,11,12,13,14MM)
10 PC. 1/4" DR. 6PT. DEEP SOCKET(4,5,6,7,8,9,10,11,12,13MM)
6 PC. 1/4" DR. BIT SOCKET, HEXAGON(3,4,5,6,7,8MM)
3 PC. 1/4" DR. BIT SOCKET, PHILLIPS(#1,#2,#3)
3 PC. 1/4" DR. BIT SOCKET, POZIDRIV(#1,#2,#3)
3 PC. 1/4" DR. BIT SOCKET, SLOTTED(4, 5,5,6,5MM)
7 PC. 1/4" DR. BIT SOCKET, TORX (T8,T10,T15,T20,T25,T30,T40)
1 PC. 3/8" DR. QUICK RELEASE RATCHET W/GRIP 8"
3 PC. 3/8" DR. EXTENSION BAR (3",6", 10")
1 PC. 3/8" DR. SLIDING T-HANDLE 8"
1 PC. UNIVERSAL JOINT, 3/8"FX3/8"M
1 PC. SOCKET ADAPTOR, 3/8"FX1/4"M
1 PC. SOCKET ADAPTOR, 3/8"FX1/2"M
2 PC. 3/8" DR. SPARK PLUG SOCKET (16MM 21MM)
1 PC. 3/8" DR. 12PT/W SPARK SOCKET 14MM
1 PC. 3/8" DR. SLIDING HEAD, 3/8"MX1/2"Z"
1 PC. 1/4" DR. QUICK RELEASE RATCHET W/GRIP 5"
2 PC. 1/4" DR. EXTENSION BAR (2", 4")
1 PC. 1/4" DR. SLIDING T-HANDLE 4"
1 PC. 1/4" DR. SOCKET DRIVER

Product Name
1 PC. UNIVERSAL JOINT, 1/4"FX1/4"M
1 PC. SOCKET ADAPTOR, 1/4"FX3/8"M
1 PC. 1/4" FLEX EXTENSION 6" (SATA#11922)
1 PC. BIT SOCKET FOR ENGINE COVER REWS
1 PC. 1/2" DR. M16 OIL PAN BITS SOCKET
1 PC. 1/2" DR. H17 OIL PAN BITS SOCKET

**Fifth Layer**

Product Name
11 PC. FULL POLISH BOX END WRENCH (10X12, 12x14,13x15,13x16,14x17,16x18,17x19,19x21,19x22,22x24,24x27MM)
2 PC. T SERIES GO-THR. REWDRIVER, SL (8X150, 8X200MM)
2 PC. T SERIES GO-THR. REWDRIVER, PH(#3X150MM,#3X200MM)
12 PC. FULL POLISH PIPE WRENCH(6,7,8,9,10,11,12,13,14,15,16,17MM)
1 PC. ADJUSTABLE WRENCH 10"

**Sixth Layer**

Product Name
1 PC FLEXIBLE MEGNETIC PICKUP TOOL 400MMX1KG
1 PC SCREWDRIVER
5 PC. WITHDRAWAL TOOLS FOR INTERIOR TRIM
9 PC. EXTRA LONG BALL POINT HEX KEY SET
9 PC. LONG ARM TORX KEY SET
5 PC. PUNCH SET
5 PC. FINE THREADED EXTRACTOR SET
1 PC. AUTOMOTIVE CIRCUIT TESTER 6V/12V/24V
1 PC. AIR BLOW GUN + BRASS AIR INLET 100mm
1 PC. PLASTIC SNAP-OFF KNIFE, 13-POINT, 9X80MM
1 PC. FIBERGLASS HANDLE BALL PEIN HAMMER 1.5LB
1 PC. DEAD BLOW HAMMER 55MM
14PC. FEELER GAUGES SET 0.05-1.00MM
1 PC. UNIVERSAL 3-JAW OIL FILTER WRENCH(63-102MM)

▲ General repair tool set, can meet most demand of daily repair and maintenance in general repair shop and chained Store







- One-station MRO tools solution, satisfy the daily demands of new workshop;
- EVA mats design, environmentally-friendly and healthy;
- Organized, not easily lost;
- SATA high quality tools, lifetime warranty.

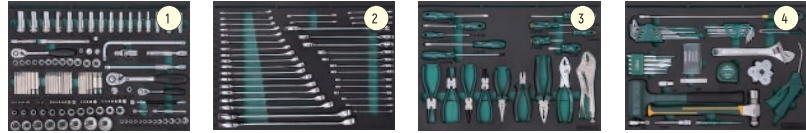

**First Layer**

Product Name
1/2" DR. 6PT. SOCKET 8MM
1/2" DR. 6PT. SOCKET 9MM
1/2" DR. 6PT. SOCKET 10MM
1/2" DR. 6PT. SOCKET 11MM
1/2" DR. 6PT. SOCKET 12MM
1/2" DR. 6PT. SOCKET 13MM
1/2" DR. 6PT. SOCKET 14MM
1/2" DR. 6PT. SOCKET 15MM
1/2" DR. 6PT. SOCKET 16MM
1/2" DR. 6PT. SOCKET 17MM
1/2" DR. 6PT. SOCKET 18MM
1/2" DR. 6PT. SOCKET 19MM
1/2" DR. 6PT. SOCKET 20MM
1/2" DR. 6PT. SOCKET 21MM
1/2" DR. 6PT. SOCKET 22MM
1/2" DR. 6PT. SOCKET 23MM
1/2" DR. 6PT. SOCKET 24MM
1/2" DR. 6PT. SOCKET 27MM
1/2" DR. 6PT. SOCKET 30MM
1/2" DR. 6PT. SOCKET 32MM
3/8" DR. 6PT. DEEP SOCKET 10MM
3/8" DR. 6PT. DEEP SOCKET 11MM
3/8" DR. 6PT. DEEP SOCKET 12MM
3/8" DR. 6PT. DEEP SOCKET 13MM
3/8" DR. 6PT. DEEP SOCKET 14MM
3/8" DR. 6PT. DEEP SOCKET 15MM
3/8" DR. 6PT. DEEP SOCKET 16MM
3/8" DR. 6PT. DEEP SOCKET 17MM
3/8" DR. 6PT. DEEP SOCKET 18MM
3/8" DR. 6PT. DEEP SOCKET 19MM
3/8" DR. 6PT. DEEP SOCKET 20MM
3/8" DR. 6PT. DEEP SOCKET 21MM
3/8" DR. 6PT. DEEP SOCKET 22MM
3/8" DR. 6PT. SOCKET 8MM

Product Name
3/8" DR. 6PT. SOCKET 9MM
3/8" DR. 6PT. SOCKET 10MM
3/8" DR. 6PT. SOCKET 11MM
3/8" DR. 6PT. SOCKET 12MM
3/8" DR. 6PT. SOCKET 13MM
3/8" DR. 6PT. SOCKET 14MM
3/8" DR. 6PT. SOCKET 15MM
3/8" DR. 6PT. SOCKET 16MM
3/8" DR. 6PT. SOCKET 17MM
3/8" DR. 6PT. SOCKET 18MM
3/8" DR. 6PT. SOCKET 19MM
1/4" DR. 6PT. SOCKET 4MM
1/4" DR. 6PT. SOCKET 4.5MM
1/4" DR. 6PT. SOCKET 5MM
1/4" DR. 6PT. SOCKET 5.5MM
1/4" DR. 6PT. SOCKET 6MM
1/4" DR. 6PT. SOCKET 7MM
1/4" DR. 6PT. SOCKET 8MM
1/4" DR. 6PT. SOCKET 9MM
1/4" DR. 6PT. SOCKET 10MM
1/4" DR. 6PT. SOCKET 11MM
1/4" DR. 6PT. SOCKET 12MM
1/4" DR. 6PT. SOCKET 13MM
1/4" DR. 6PT. SOCKET 14MM
1/4" DR. QUICK RELEASE RATCHET W/GRIP 5"
3/8" DR. QUICK RELEASE RATCHET W/GRIP 8"
1/2" DR. QUICK RELEASE RATCHET W/GRIP10"
1/2" DR. L-SHAPED WRENCH 10"
1/4" DR. EXTENSION BAR 2"
1/4" DR. EXTENSION BAR 4"
3/8" DR. EXTENSION BAR 3"
3/8" DR. EXTENSION BAR 6"
1/2" DR. EXTENSION BAR 5"
1/2" DR. EXTENSION BAR 10"

Product Name
UNIVERSAL JOINT, 1/4"FX1/4" M
UNIVERSAL JOINT, 3/8"FX3/8" M
UNIVERSAL JOINT, 1/2"FX1/2" M
1/4" FLEX EXTENSION 6" (SATA#11922)
SOCKET ADAPTOR, 3/8"FX1/4" M
SOCKET ADAPTOR, 3/8"FX1/2" M
SOCKET ADAPTOR, 1/2"FX3/8" M
3/8" DR. 12PT/W SPARK SOCKET 14MM
3/8" DR. SPARK PLUG SOCKET 16MM
3/8" DR. SPARK PLUG SOCKET 21MM
5PC. 8MM HEX BITS, 30MM, SLOTTED 5.5MM
5PC. 8MM HEX BITS, 30MM, SLOTTED 6.5MM
5PC. 8MM HEX BITS, 30MM, SLOTTED 8MM
5PC. 8MM HEX BITS, 30MM, SLOTTED 10MM
5PC. 8MM HEX BITS, 30MM, SLOTTED 12MM
Tap Adaptor M3-M4
Tap Adaptor M5-M12
Die Adaptor M3-M12
5PC. 8MM HEX BITS, 30MM, RESISTORX TT20
5PC. 8MM HEX BITS, 30MM, RESISTORX TT25
5PC. 8MM HEX BITS, 30MM, RESISTORX TT30
5PC. 8MM HEX BITS, 30MM, RESISTORX TT40
5PC. 8MM HEX BITS, 30MM, RESISTORX TT45
5PC. 8MM HEX BITS, 30MM, RESISTORX TT50
5PC. 8MM HEX BITS, 30MM, RESISTORX TT55
5PC. 8MM HEX BITS, 30MM, RESISTORX TT60
5PC. 8MM HEX BITS, 30MM, 12PT. M5
5PC. 8MM HEX BITS, 30MM, 12PT. M6
5PC. 8MM HEX BITS, 30MM, 12PT. M8
5PC. 8MM HEX BITS, 30MM, 12PT. M10
5PC. 8MM HEX BITS, 30MM, 12PT. M12
5PC. 8MM HEX BITS, 30MM, HEXAGON 4MM
5PC. 8MM HEX BITS, 30MM, HEXAGON 5MM
5PC. 8MM HEX BITS, 30MM, HEXAGON 6MM
5PC. 8MM HEX BITS, 30MM, HEXAGON 7MM
5PC. 8MM HEX BITS, 30MM, HEXAGON 8MM
5PC. 8MM HEX BITS, 30MM, HEXAGON 10MM
5PC. 8MM HEX BITS, 30MM, HEXAGON 12MM
5PC. 8MM HEX BITS, 30MM, HEXAGON 14MM
BIT ADAPTOR, 1/2"FX5/16" HEX
BIT ADAPTOR, 3/8"FX5/16"HEX

Product Name
5PC. 8MM HEX BITS, 30MM, HEXAGON 7MM
5PC. 8MM HEX BITS, 30MM, HEXAGON 8MM
5PC. 8MM HEX BITS, 30MM, HEXAGON 10MM
5PC. 8MM HEX BITS, 30MM, HEXAGON 12MM
5PC. 8MM HEX BITS, 70MM, SLOTTED 8MM
5PC. 8MM HEX BITS, 70MM, PHILLIPS #2
5PC. 8MM HEX BITS, 70MM, TORX T20
5PC. 8MM HEX BITS, 70MM, TORX T25
5PC. 8MM HEX BITS, 70MM, TORX T27
5PC. 8MM HEX BITS, 70MM, TORX T30
5PC. 8MM HEX BITS, 70MM, TORX T40
5PC. 8MM HEX BITS, 70MM, TORX T45
5PC. 8MM HEX BITS, 70MM, TORX T50
5PC. 8MM HEX BITS, 70MM, TORX T55
5PC. 8MM HEX BITS, 70MM, 12PT. M5
5PC. 8MM HEX BITS, 70MM, 12PT. M6
5PC. 8MM HEX BITS, 70MM, 12PT. M8
5PC. 8MM HEX BITS, 70MM, 12PT. M10
5PC. 8MM HEX BITS, 70MM, 12PT. M12
5PC. 8MM HEX BITS, 70MM, 12PT. M14
5PC. 8MM HEX BITS, 70MM, 12PT. M16
5PC. 8MM HEX BITS, 70MM, HEXAGON 4MM
5PC. 8MM HEX BITS, 70MM, HEXAGON 5MM
5PC. 8MM HEX BITS, 70MM, HEXAGON 6MM
5PC. 8MM HEX BITS, 70MM, HEXAGON 7MM
5PC. 8MM HEX BITS, 70MM, HEXAGON 8MM
5PC. 8MM HEX BITS, 70MM, HEXAGON 10MM
5PC. 8MM HEX BITS, 70MM, HEXAGON 12MM
5PC. 8MM HEX BITS, 70MM, HEXAGON 14MM
BIT ADAPTOR, 1/2"FX5/16" HEX
BIT ADAPTOR, 3/8"FX5/16"HEX

**Second Layer**

Product Name
FULL POLISH COMBINATION WRENCH 6MM
FULL POLISH COMBINATION WRENCH 7MM
FULL POLISH COMBINATION WRENCH 8MM
FULL POLISH COMBINATION WRENCH 9MM
FULL POLISH COMBINATION WRENCH 10MM
FULL POLISH COMBINATION WRENCH 11MM
FULL POLISH COMBINATION WRENCH 12MM
FULL POLISH COMBINATION WRENCH 13MM
FULL POLISH COMBINATION WRENCH 14MM
FULL POLISH COMBINATION WRENCH 15MM
FULL POLISH COMBINATION WRENCH 16MM
FULL POLISH COMBINATION WRENCH 17MM
FULL POLISH COMBINATION WRENCH 18MM
FULL POLISH COMBINATION WRENCH 19MM
FULL POLISH COMBINATION WRENCH 20MM
FULL POLISH COMBINATION WRENCH 21MM
FULL POLISH COMBINATION WRENCH 22MM
FULL POLISH COMBINATION WRENCH 23MM

Product Name
FULL POLISH COMBINATION WRENCH 24MM
FULL POLISH COMBINATION WRENCH 25MM
FULL POLISH COMBINATION WRENCH 27MM
FULL POLISH COMBINATION WRENCH 30MM
FULL POLISH COMBINATION WRENCH 32MM
FULL POLISH OPEN END WRENCH 6X7MM
FULL POLISH OPEN END WRENCH 8X10MM
FULL POLISH OPEN END WRENCH 10X12MM
FULL POLISH OPEN END WRENCH 12X14MM
FULL POLISH OPEN END WRENCH 13X15MM
FULL POLISH OPEN END WRENCH 13X16MM
FULL POLISH OPEN END WRENCH 14X17MM
FULL POLISH OPEN END WRENCH 16X18MM
FULL POLISH OPEN END WRENCH 17X19MM
FULL POLISH OPEN END WRENCH 19X21MM
FULL POLISH OPEN END WRENCH 16X18MM
FULL POLISH OPEN END WRENCH 22X24MM
FULL POLISH OPEN END WRENCH 24X27MM
FULL POLISH OPEN END WRENCH 30X32MM

**Third Layer**

Product Name
GER. EXTER. SNAP RING PLIER 7" STRAIGHT
GER. EXTER. SNAP RING PLIER 7" CURVED
GER. INTER. SNAP RING PLIER 7" STRAIGHT
GER. INTER. SNAP RING PLIER 7" CURVED
LONG NOSE PLIERS 6"
DIAGONAL PLIERS 6"
COMBINATION PLIERS 8"
SLIP JOINT PLIERS 8"
10" CURVED JAW LOCKING PLIER W/CUT
A SERIES GO THROUGH SD.SL6X150MM
A SERIES GO THROUGH SD.PH#2X150MM
A SERIES REWDRIWER, SLOTTED 3.2X75MM
A SERIES REWDRIWER, SLOTTED 5X100MM
A SERIES REWDRIWER, SLOTTED 6X38MM
A SERIES REWDRIWER, SLOTTED 6X100MM
A SERIES REWDRIWER, PHILLIPS #0X75MM
A SERIES REWDRIWER, PHILLIPS #1X75MM
A SERIES REWDRIWER, PHILLIPS #2X38MM
A SERIES REWDRIWER, PHILLIPS #2X100MM

**Fourth Layer**

Product Name
FLEXIBLE MEGNETIC PICKUP TOOL 400MMX1KG
9PC. EXTRA LONG BALL POINT HEX KEY SET
9PC. LONG ARM TORX KEY SET
5PCS PUNCH SET
5PC. FINE THREADED EXTRACTOR SET
BIT SOCKET FOR ENGINE COVER REWS
1/2" DR. M16 OIL PAN BITS SOCKET
1/2" DR. H17 OIL PAN BITS SOCKET
AUTOMOTIVE CIRCUIT TESTER 6V/12V/24V
AIR BLOW GUN - BRASS AIR INLET 100mm
PLASTIC SNAP-OFF KNIFE, 13-POINT, 9X80MM
FIBERGLASS HANDLE BALL PEIN HAMMER 1.5LB
DEAD BLOW HAMMER 55MM
14PC. FEELER GAUGES SET 0.05-1.00MM
ABS CASE TAPE MEASURE 5MX19MM
UNIVERSAL 3-JAW OIL FILTER WRENCH
ADJUSTABLE WRENCH 10"

▲ General repair tool set, can meet most demand of daily repair and maintenance in general repair shop and chained Store



**95124 2 DRAWERS 2 DOOR TOOL TROLLEY (27INCHES)**



No.	LxWxH (MM)	N.W.(KG)
95124	692x468x840(±3)	48

- The trolley body use high quality cold-rolled steel plates, high strength and more durable
- Drawer inner size(small): 577x404x57mm (tolerance: ±2mm) 1pc
- Drawer inner size(big): 577x404x130mm (tolerance: ±2mm) 1pc
- 45mm reinforced ball bearing slides help single drawer with max load capacity can be opened or closed smoothly
- 5-inch heavy duty casters, moving smoothly, with low noise and longer working life
- Thickened glossy aluminum alloy handle, more beautiful and durable
- Double-color spray-paint technology, beautiful and durable
- All drawers with EVA mats inside
- Overall static rated load 300KGS
- Double-door interior partition adjustable, free to set up upper and lower space, easy to place large pneumatic tools
- Do not open more than 2 drawers at the same time to prevent the product from tilting. Each layer of drawers capacity is 45KGS

**95126 6 DRAWERS TOOL TROLLEY (27INCHES)**



No.	LxWxH (MM)	N.W.(KG)
95126	692x468x840(±3)	63

- The trolley body use high quality cold-rolled steel plates, high strength and more durable
- Drawer inner size(small): 577x404x57mm (tolerance: ±2mm) 4pcs
- Drawer inner size(big): 577x404x168mm (tolerance: ±2mm) 2pcs
- 45mm reinforced ball bearing slides help single drawer with max load capacity can be opened or closed smoothly.
- 5-inch heavy duty casters, moving smoothly, with low noise and longer working life.
- Thickened glossy aluminum alloy handle, more beautiful and durable.
- Double-color spray-paint technology, beautiful and durable
- All drawers with EVA mats inside.
- Overall static rated load 300KGS
- The trolley can be moved with different workspaces and states
- Do not open more than 2 drawers at the same time to prevent the product from tilting. Each layer of drawers capacity is 45KGS

**95222A 3-Tray Multipurpose Tool Cart**



Model	LxWxH(MM)	N.W.(KG)
95222A	840x500x920(include casters and push hand)	174

- Through beam design, stronger bearing capacity

**95125 4 DRAWERS 2 DOOR TOOL TROLLEY (27INCHES)**



No.	LxWxH (MM)	N.W.(KG)
95125	692x468x840(±3)	56

- The trolley body use high quality cold-rolled steel plates, high strength and more durable
- Drawer inner size: 577x404x60mm (tolerance: ±2mm) 4pcs
- 45mm reinforced ball bearing slides help single drawer with max load capacity can be opened or closed smoothly
- 5-inch heavy duty casters, moving smoothly, with low noise and longer working life
- Thickened glossy aluminum alloy handle, more beautiful and durable
- Double-color spray-paint technology, beautiful and durable
- All drawers with EVA mats inside
- Overall static rated load 300KGS
- Double-door interior partition adjustable, free to set up upper and lower space, easy to place large pneumatic tools
- Do not open more than 2 drawers at the same time to prevent the product from tilting. Each layer of drawers capacity is 45KGS

**95127 TOOL TROLLEY BACK HANGER (WITH 20 PC HOOKS)**



No.	LxWxH (MM)	N.W.(KG)
95127	672x500x20(±2)	5

- Including 20 hooks, free combination of various hanging tools, easy to take when working
- Removable design for easy storage and transportation, high-strength cold-rolled steel plate, strong load capacity
- Do not open more than 2 drawers at the same time to prevent the product from tilting. Each layer of drawers capacity is 45KGS
- Paint color: Black matte

**95222B 3-Tray Parts Tool Cart**



Model	95222B
Rated static load(kg)	80
Rated dynamic load(kg)	45
Length(mm)	750
Width(mm)	373
Height(mm)	900
Caster size	3"
N.W.(kg)	11.2

- Through beam design, stronger bearing capacity

# J Auto Maintenance Tool

Torque wrench		52
Other tools		53-54

## 96351 1/2" Series Car Tire Preset Torque Wrench



Model	Drive head size	Set torque(N-m)	LengthxWidthxHeight(MM)	N.W.(KG)
96351	1/2"	118	578.5x40.5x40.5	2.65
<ul style="list-style-type: none"> <li>• Easy to use and effortless</li> <li>• long life</li> </ul>		<ul style="list-style-type: none"> <li>• Reversible operation</li> <li>• Used to tighten most car wheel bolts</li> </ul>		

## 96352 1/2" Series SUV Tire Preset Torque Wrench



Model	Drive head size	Set torque(N-m)	LengthxWidthxHeight(MM)	N.W.(KG)
96352	1/2"	138	578.5x40.5x40.5	2.65
<ul style="list-style-type: none"> <li>• Easy to use and effortless</li> <li>• long life</li> </ul>		<ul style="list-style-type: none"> <li>• Reversible operation</li> <li>• Used to tighten most car wheel bolts</li> </ul>		

## Work Light



AE5911

- IP65 waterproof and dustproof
- IK07 anti-vibration and impact-resistant dual color temperature
- Ra96 high CRI
- Double magnet



AE5921/AE5922

- Foldable, light and compact
- Three lights, suitable for a variety of lighting applications
- Main Light has red flash function
- Bottom magnet can fix to steel surface
- Top magnet used as a picker
- Bottom clip can be clamped on the edge of plate material
- Hidden hook can hang in suitable position
- USB Type-C charging port with charging cable



AE5923

- Smart and easy to carry
- 240lm and 80lm two levels of brightness
- Strong magnet at the bottom

Model	Luminous flux	Working Time (COB)	Charging Time	Length(mm)	Width(mm)	Height(mm)	N.W.(kg)
AE5911	350	2.5	4	190	55.9	36	0.26
AE5921	220	3	2.5	130	41.5	26.5	0.12
AE5922	360	3	4	158	45	30.5	0.18
AE5923	240	1.3	2.5	89	23	17.5	0.04



**98111 Tyre Inflator**



Rated Voltage	DC12V
Air output	30L/min
Rated Power	120W
Max. Pressure	6Bar
Output Current	10A
Pressure Precision	+2Psi

- Avoiding wetted from water and impacted
- After continuous inflating 10 mins, cool 15min at least
- After connecting the pipeline connector, manually turn on or off the switch
- When there is abnormal noise in inflation, please turn off the machine and send it to the after-sales outlet for repair

**AE5731 Deodorant sterilizer**



Formaldehyde removal rate	99.20%
Staphylococcus albicans kill rate	99.90%
Rated Voltage	DC5V
Rated Power	1.5W
Built-in 2000Ah lithium battery	single mode: 3 times, cycle mode: 4H

- Built-in ozone generator 2.02mg/m<sup>3</sup>
- Built-in 28 millionnegative Ion generator
- Built-in lithium battery, sterilization and deodorization anytime and anywhere
- Applicable area 5-15m<sup>2</sup>

**09705 25pcs Universal cap filter wrench set**



No.	Specifications
98202	27/6P
98203	32/6P
98204	36/6P
98205	Inner Dia. 64-65MM 14 teeth
98206	Inner Dia. 66-67MM 14 teeth
98207	Inner Dia. 72-73MM 14 teeth
98208	Inner Dia. 73MM 15 teeth
98209	Inner Dia. 74MM 8 teeth
98210	Inner Dia. 72-73MM 14 teeth
98211	Inner Dia. 72-73MM 15 teeth
98212	Inner Dia. 74-75MM 14 teeth
98213	Inner Dia. 75-76MM 15 teeth
98214	Inner Dia. 77MM 12 teeth
98215	Inner Dia. 78-79MM 15 teeth
98216	Inner Dia. 80MM 12 teeth
98217	Inner Dia. 79-80MM 15 teeth
98218	Inner Dia. 73-84MM 14 teeth
98219	Inner Dia. 86MM 18 teeth
98220	Inner Dia. 86-87MM 16 teeth
98221	Inner Dia. 88-89MM 15 teeth
98222	Inner Dia. 90-91MM 15 teeth
98223	Inner Dia. 91-92MM 15 teeth
98224	Inner Dia. 92-93MM 15 teeth
98225	Inner Dia. 93-94MM 15 teeth
98226	Inner Dia. 101MM 15 teeth

- For the removal and installation of the filter.
- It adopts imported high carbon stretching materials, plate thickening and heat treatment quality process, surface treatment black electrophoresis, expansion of the tight design, solve the impact of small errors.

**AE5809 Battery And Circuit System Analyser**



Ambient Temperature	From -18°C to 50°C	Engine starting system test	Yes
Battery application	Normal lead-acid battery/AGM/EFB	Circuit charging system test	Yes
Temperature compensation algorithm	Yes	Display the test result	Yes
Test technology	Conductometry	Print the test result	Yes
Built-in printer	Yes	Display voltage data	Yes
Possible spark risk	No	Language	English/Chinese
Wrong polarity connection protection	Yes	Userinfo setup	Yes
Package size(mm)	260*160*115	Battery Voltage	12V
Net weight(KG)	0.6	MOQ	50

**Features:**

- With intelligent battery test system, more fast test speed and high accuracy rate
- Easy and simple to operate, just follow up the system prompts
- Built-in printer, easy to get the test result

**AE5931 SWIVEL JAW HOSE CLAMP PLIERS**



- Applying to quick release pipe clamp, easy to disassemble water pipe, avoiding the harm from violent disassembly.
- Adjustable ratchet structure can quick tighten and release, applying to pipes in lower position.
- Rotated top concave is easy to fit clamp, applying to small space.
- Plier head and top concave formed by excellent steel with heat treatment assure lifetime.
- thicker and bigger handle with two color PVC dipped, more comfortable, more labor saving.
- Whole length of product is 9" (230mm).

⚠ This product is consumable, not within SATA lifetime warranty

**AE5937 8PC ADJUST TIGHTENER WRENCH TOOL KIT**



- Disassemble and replace the generator belt by pulling the elastic idler/tensioner pulley
- Apply to idlers and tensioners pulley with 15mm, 16mm, 18mm hex or 3/8" or 1/2" square drives
- Equipped with 1/2" drive head long rod, equipped with 3/8" drive head conversion rod
- Equipped with 15mm/16mm/18mm/ 3/8" socket. Equipped with 13mm/14mm/15mm horn wrench
- The long and short connecting rods are made of high-quality steel with the head heat-treated

⚠ This product is consumable, not within SATA lifetime warranty

**AE5953 TRIM PAD REMOVER**



- The flat head and opening of the special stamping process ensure a smooth fit to the panel. Reasonable head angle and handle design make work more labor-saving, smoothly take out the interior plastic buckle, and complete the internal plastic board disassembly work.
- The shank is made of high-quality steel with heat treatment, and the surface is chrome-plated
- The diameter of the shank is 9mm, and the overall length is 222mm.

⚠ This product is consumable, not within SATA lifetime warranty

**AE5932 HOSE CLAMP PLIERS**



- Applying to quick release pipe clamp, easy to disassemble water pipe, avoiding the harm from violent disassembly. More reachable than straight one
- Adjustable ratchet structure can quick tighten and release, applying to pipes in lower position.
- Rotated top concave is easy to fit clamp, applying to small space.
- Plier head and top concave formed by excellent steel with heat treatment assure lifetime.
- thicker and bigger handle with two color PVC dipped, more comfortable, more labor saving.
- Whole length of product is 9" (230mm).

⚠ This product is consumable, not within SATA lifetime warranty

**AE5938 20PC BRAKE CALIPER WIND BACK TOOL SET**



- It is used to reset the piston of the brake cylinder when replacing the brake pads.
- Provides positive and negative screw and screw sets and 17pcs connecting pieces, which can meet the needs of most models.
- made of high-quality steel and key parts with heat treatment, round pin material 40Cr alloy steel
- Surface Anti-rust treatment with a special gray phosphate

⚠ This product is consumable, not within SATA lifetime warranty

**AE5954 TRIM PAD REMOVER**



- The flat head and opening of the special stamping process ensure a smooth fit to the panel. Reasonable head angle and handle design make work more labor-saving, smoothly take out the interior plastic buckle, and complete the internal plastic board disassembly work.
- The shank is made of high-quality steel with heat treatment, and the surface is chrome-plated
- The diameter of the shank is 6mm, and the overall length is 205mm.

⚠ This product is consumable, not within SATA lifetime warranty

**AE5934 RIGHT ANGLE SURE GRIP TRIM CLIP PLIER**



- Disassemble metal clamp safely, which can be used again. Avoid damage to clamp. Save cost and increase efficient.
- Three slots are designed for metal clamps with different size
- Plier head made of excellent steel with heat treatment assure lifetime.
- Lengthened handle with two color PVC dipped, more comfortable, more labor saving.
- Whole length of product is 220mm

⚠ This product is consumable, not within SATA lifetime warranty

**AE5941 7PC SENSOR & SENDING UNIT SOCKET SET**



- Because the oxygen sensor is connected to the signal line and the heating line, and the narrow space in the car, it is difficult to complete this work with ordinary sleeves and hand tools. A special oxygen sensor wrench can make this job easy.
- Multi-specification sleeve is suitable for disassembly and replacement of different car oxidation sensors
- Suitable for dismantling some models of coolant temperature sensor and oil pressure switch
- made of high-quality 42 chromium molybdenum steel, which improves the toughness and wear resistance, and improves the lifetime. The surface is treated with electrophoretic paint.

⚠ This product is consumable, not within SATA lifetime warranty

**AE5955 11PC AUTO FASTENER & MOLDING REMOVAL SET**



- When using metal tools to disassemble car interiors, plastic parts, chrome plating of parts, and leather are often damaged, which can cause various losses. This product will effectively reduce such problems. The kit includes 11 unique tools that can be used to remove various fasteners and molded parts.
- For interior and exterior vehicle styling and decorative fasteners
- The plastic structure of the tool prevents scratches and damage to car paint, leather, chrome, etc.

⚠ This product is consumable, not within SATA lifetime warranty

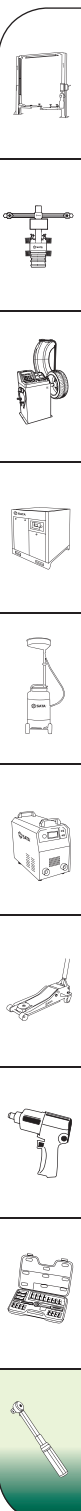

No.	Page	No.	Page	No.	Page
01111	39	AE3005	35	AE5809	53
01118	39	AE3006	35	AE5811	23
01119	39	AE3007	35	AE5812	23
01133	39	AE3008	35	AE5813	23
01401	40	AE3009	35	AE5818	24
01501	40	AE3010	35	AE5821	37
01503	40	AE3015	35	AE5822	25
01511K	40	AE3016	35	AE5822	37
090146	41	AE3017	35	AE5828	6
09705	53	AE3018	35	AE5831	37
09924	46	AE3019	35	AE5832	37
09925	47	AE3101	33	AE5841	37
09930	48	AE3101-3	33	AE5851	21
09931	49	AE3102	33	AE5861	38
09932	50	AE3102-3	33	AE5862	38
09941	41	AE3111	34	AE5881	25
09942	42	AE3121	34	AE5883	25
09943	42	AE5002	10	AE5896P	25
09944	42	AE5002-3	10	AE5896Q	25
09945	43	AE5102	7	AE5896S	25
09946	43	AE5102-3	7	AE5897P	25
09947	44	AE5103A	8	AE5897Q	25
09948	45	AE5103A-3	8	AE5897S	25
51073A	40	AE5152	9	AE5901	32
95124	51	AE5152-3	9	AE5903	24
95125	51	AE5202	4	AE5903-3	24
95126	51	AE5202-3	4	AE5904	24
95127	51	AE5302	1	AE5904-3	24
95222A	51	AE5302-3	1	AE5911	52
95222B	51	AE5402	2	AE5921	52
96351	52	AE5402-3	2	AE5922	52
96352	52	AE5402A	3	AE5923	52
97813	36	AE5402A-3	3	AE5931	54
97813A	36	AE5502	5	AE5932	54
97821	36	AE5502-3	5	AE5934	54
98101	21	AE5505	5	AE5937	54
98103	21	AE5505-3	5	AE5938	54
98104	21	AE5510	6	AE5941	54
98105	21	AE5510-3	6	AE5953	54
98107	21	AE5602T	11	AE5954	54
98111	53	AE5603	12	AE5955	54
AE1015	15	AE5606S	12	AE5971	34
AE1015-3	15	AE5701	26	AE7002	30
AE1015H	15	AE5702	26	AE7004	30
AE1015H-3	15	AE5704	26	AE7021-3	31
AE1016H	16	AE5705	27	AE7022	31
AE1016H-3	16	AE5706	27		
AE1017H	16	AE5707	27		
AE1017H-3	16	AE5708	27		
AE1018H	17	AE5721	22		
AE1018H-3	17	AE5723	22		
AE1021	13	AE5731	53		
AE1021-3	13	AE5732	31		
AE1021H	13	AE5736	32		
AE1021H-3	13	AE5741	29		
AE1022H	14	AE5742	29		
AE1022H-3	14	AE5743	29		
AE1023H	14	AE5751	28		
AE1023H-3	14	AE5752	28		
AE2011	17	AE5753	28		
AE2015	18	AE5760	29		
AE2016	19	AE5771	28		
AE2021	20	AE5775	28		
AE2022	20	AE5801	23		
AE3001	35	AE5802	23		
AE3002	35	AE5803	23		
AE3003	35	AE5806	22		
AE3004	35	AE5808	22		

## Terms and Conditions

### Lifetime warranty terms

All **SATA** products, except those with "non-lifetime-warranty" or "warranty period" marked on the package or sample documentation, and those belong to situations not listed in the following second part "Situations not covered by free repair or replacement", can be repaired, even replaced with the same product for free if they suffer to defective functions under normal use. For warranty terms, please refer to information on the product package. This commitment is not limited by time.

### Situations not covered by free repair or replacement

Non-SATA **SATA** branded products.

Wear beyond the service life of the product.

SATA products with "non-lifetime-warranty" or "warranty period" marked on the product package or sample documentation.

Products nonoperational due to abnormal use. Abnormal use such as: man-made destruction, used not according to precautions for tool usage, beyond operation scope of the tool.

The customer has machined the product or changed the accessories without authorization, or any accessory is lost.

Rusts, plating peeling, surface scratches or damaged plastic handle occurred after use, which do not influence functions of the product.

Product packaging materials (such as trays, shelves, plastic covers, paper cards etc) are damaged during use.

### How to repair or replace

For products within free repair or free replacement scope, the user can go to the nearest **SATA** SATA designated sales shop to fill in the product warranty card and enjoy free repair even replacement, not requiring any proof.

Free repair or replacement should observe the principle of repairs first and replacement last.

If the components or product is not available in the shop, SATA will send them to the shop by post.

For products not covered by free repair, the designated shop will provide replacement of components with charge.

### Service consulting

If you have any question about warranty terms for **SATA** products, or if you are not satisfied with the service provided by the designated shop, please contact SATA Tool (Shanghai) Limited (021) 60611919 or (800) 8203885.

### Power of interpretation

Power of interpretation of these terms belong to SATA Tool (Shanghai) Limited

**⚠ Please use the tool correctly** Following are situation where tools are not appropriately used:

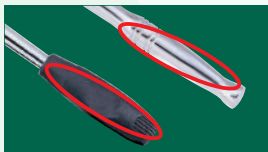

If the ratchet wrench handle has obvious dents or stripped plating, it means that this handle has been abnormally hit or used with a long handle (to cover long pipes). You should select a ratchet wrench with larger size to increase torque.



If the saugre hole on the socket has obvious damages, or the drum wall has obvious cracks, it means the socket has been used on a pneumatic tool. When using sockets on pneumatic operations, please choose pneumatic series sockets, which are usually black.

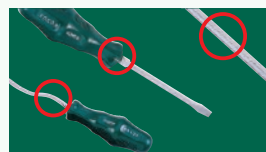

If the screwdriver handle is cracked or the rod is twisted, it means that this screwdriver has been hit or been used as a crowbar. Use appropriate crowbar tools when you perform levering operations.

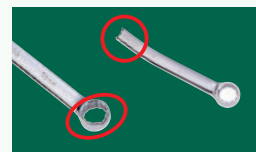

If any combination wrench is bent or broken, it means that this wrench has been used to hit or as a crowbar. Use appropriate crowbar tools when you perform levering operations.



## SATA Automotive Technology (Shanghai) Co.,Ltd.

Add: 5-12, NO 988, JingTang Road, Nanxiang Town, Jiading District, Shanghai 201800

Tel: (86 21) 6061 7345

Fax: (86 21) 6061 1918